

**SF2204E-1**

**1900 MHz  
SAW Filter**

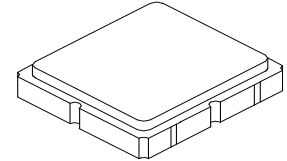

**SM3030-6**

- **Low-loss RF SAW Filter**
- **Low Amplitude Ripple**
- **No Matching Required for 50Ω Operation**
- **Complies with Directive 2002/95/EC (RoHS)**
- **Moisture Sensitivity Level: 1**

**Absolute Maximum Ratings**

Rating	Value	Units
Input Power Level	15	dBm
DC Voltage on any Non-ground Terminal	12	V
Operating Temperature Range	-40 to +85	°C
Storage Temperature Range in Tape and Reel	-40 to +85	°C
Maximum Soldering Profile, 5 Cycles/10 seconds Maximum	265	°C

**Electrical Characteristics**

Characteristic	Sym	Notes	Min	Typ	Max	Units
Center Frequency	$f_c$			1900		MHz
Insertion Loss, 1880 to 1920 MHz	IL			1.8	3.0	dB
Amplitude Ripple, 1880 to 1920 MHz				0.6	1.3	dB <sub>P,P</sub>
VSWR, 1880 to 1920 MHz				1.4:1	2.0:1	
Attenuation Referenced to 0 dB:						
0.3 to 960 MHz			30	34		dB
960 to 1805 MHz			30	34		
1805 to 1830 MHz			30	35		
1830 to 1850 MHz			30	35		
1950 to 2010 MHz			15	30		
2010 to 2025 MHz			40	45		
2110 to 2170 MHz			35	44		
2300 to 2400 MHz			35	40		
2400 to 3000 MHz			28	33		
Source Impedance	$Z_s$			50		Ω
Load Impedance	$Z_L$			50		Ω

Case Style	SM3030-6 3.0 x 3.0 mm Nominal Footprint		
Lid Symbolization, Y=year, WW=week, S=shift, Dot=pin 1 indicator	976, <u>YWWS</u>		
Standard Reel Quantity	Reel Size 7 Inch	500 Pieces/Reel	
	Reel Size 13 Inch	3000 Pieces/Reel	

**Electrical Connections**

Connection	Terminals
Port 1	2
Port 2	5
Case Ground	All others

 **CAUTION: Electrostatic Sensitive Device. Observe precautions for handling.**

**NOTES:**

1. The design, manufacturing process, and specifications of this device are subject to change.
2. US or International patents may apply.
3. RoHS compliant from the first date of manufacture.

# Filter Response Plots

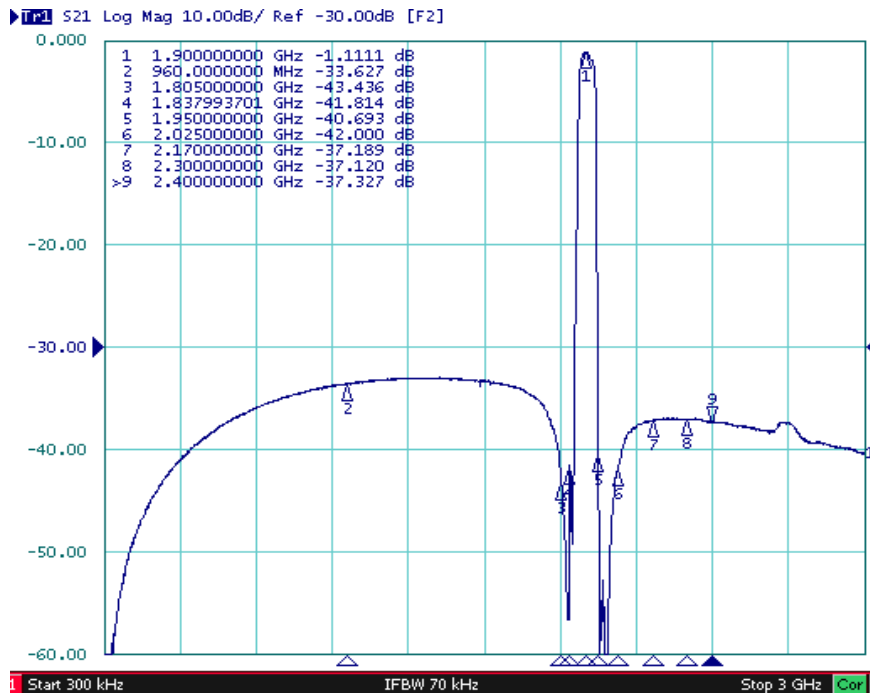
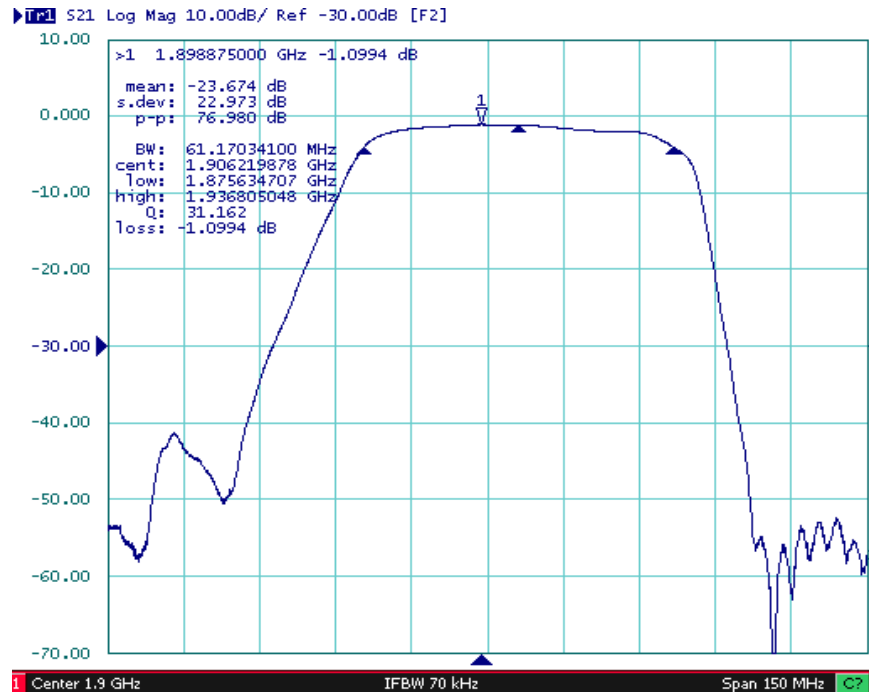

# Filter Input/Output SWR Plots

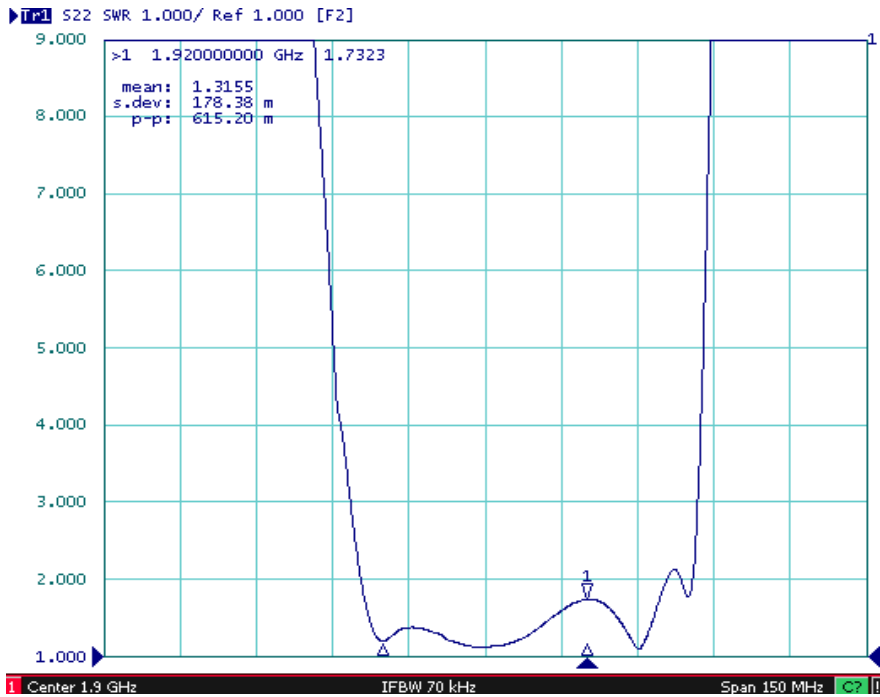
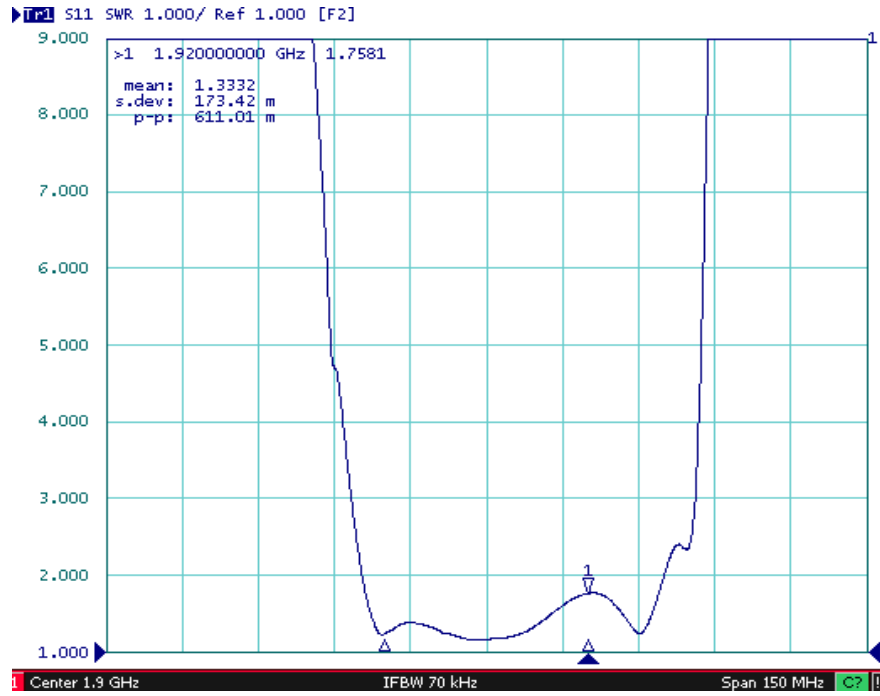

# Filter Input/Output Impedance Plots

▶ Tr1 S11 Smith (R+jX) Scale 1.000U [F2]

>1 1.900000000 GHz 51.959  $\Omega$  -7.1624  $\Omega$  11.695 pF

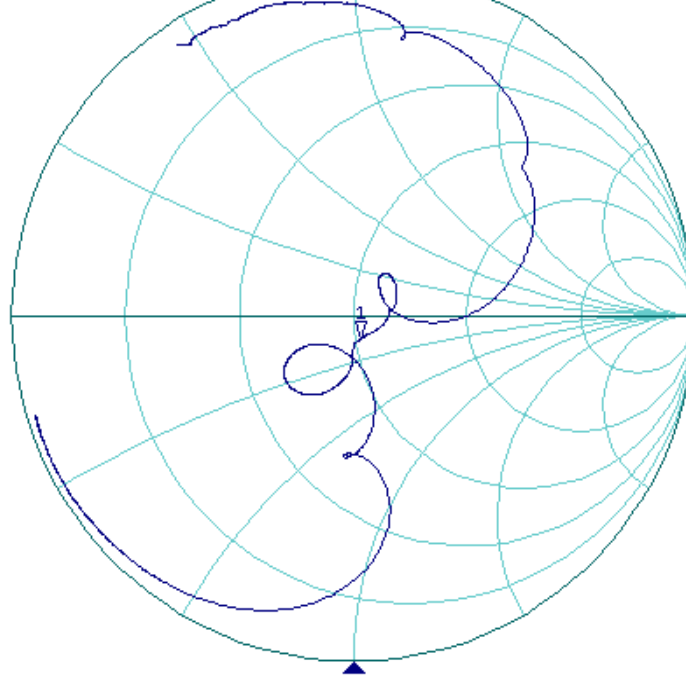

Center 1.9 GHz IFBW 70 kHz Span 150 MHz

▶ Tr1 S22 Smith (R+jX) Scale 1.000U [F2]

>1 1.900000000 GHz 54.855  $\Omega$  -3.3180  $\Omega$  25.246 pF

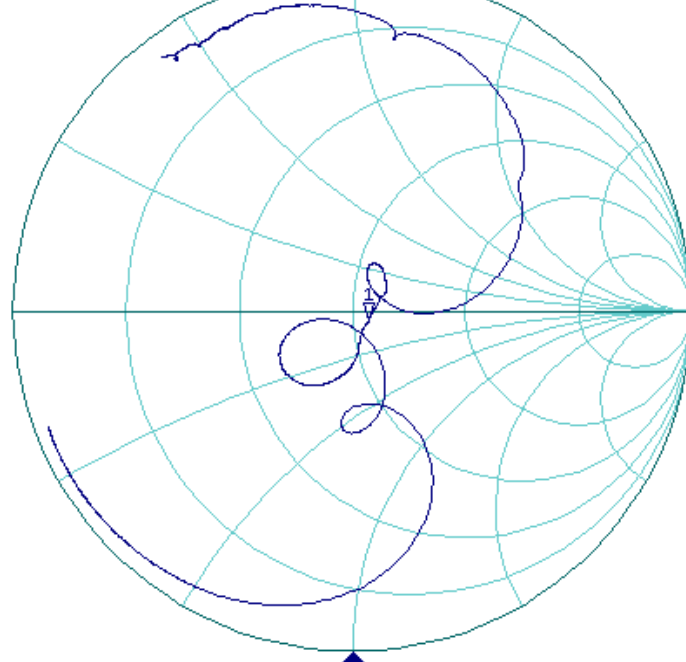

Center 1.9 GHz IFBW 70 kHz Span 150 MHz

# SM3030-6 Case

## 6-Terminal Ceramic Surface-Mount Case 3.0 X 3.0 mm Nominal Footprint

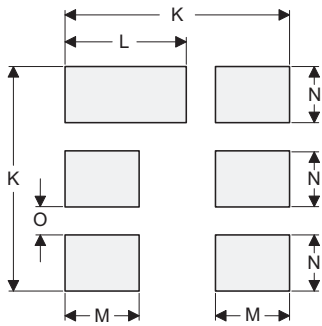
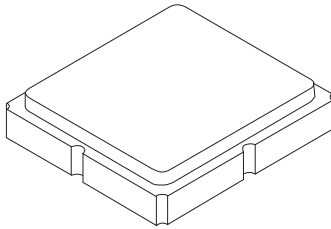

PCB Footprint Top View

### Case and PCB Footprint Dimensions

Dimension	mm			Inches		
	Min	Nom	Max	Min	Nom	Max
A	2.87	3.00	3.13	0.113	0.118	0.123
B	2.87	3.00	3.13	0.113	0.118	0.123
C	1.12	1.25	1.40	0.044	0.049	0.055
D	0.77	0.90	1.03	0.030	0.035	0.040
E	2.67	2.80	2.93	0.105	0.110	0.115
F	1.47	1.60	1.73	0.058	0.063	0.068
G	0.72	0.85	0.98	0.028	0.033	0.038
H	1.37	1.50	1.63	0.054	0.059	0.064
I	0.47	0.60	0.73	0.019	0.024	0.029
J	1.17	1.30	1.43	0.046	0.051	0.056
K		3.20			0.126	
L		1.70			0.067	
M		1.05			0.041	
N		0.81			0.032	
O		0.38			0.015	

### Case Materials

Materials	
Solder Pad Plating	0.3 to 1.0 $\mu\text{m}$ Gold over 1.27 to 8.89 $\mu\text{m}$ Nickel
Lid Plating	2.0 to 3.0 $\mu\text{m}$ Nickel
Body	$\text{Al}_2\text{O}_3$ Ceramic

### Top View

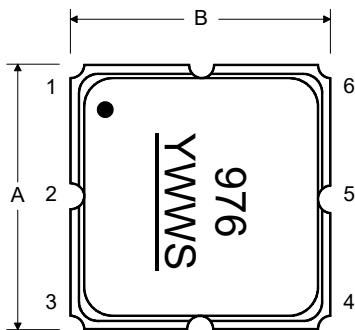

### Bottom View

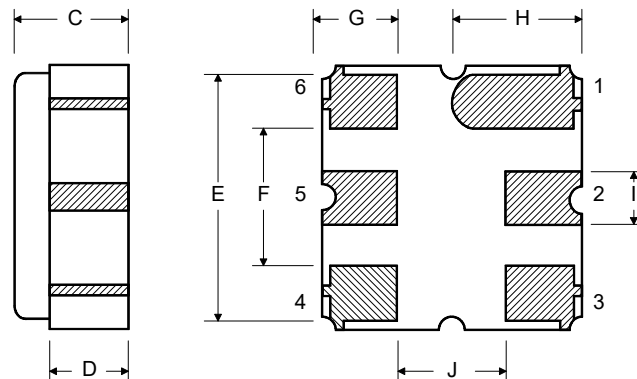

## Tape and Reel Specifications

Tape and Reel Standard per ANSI/EIA-481

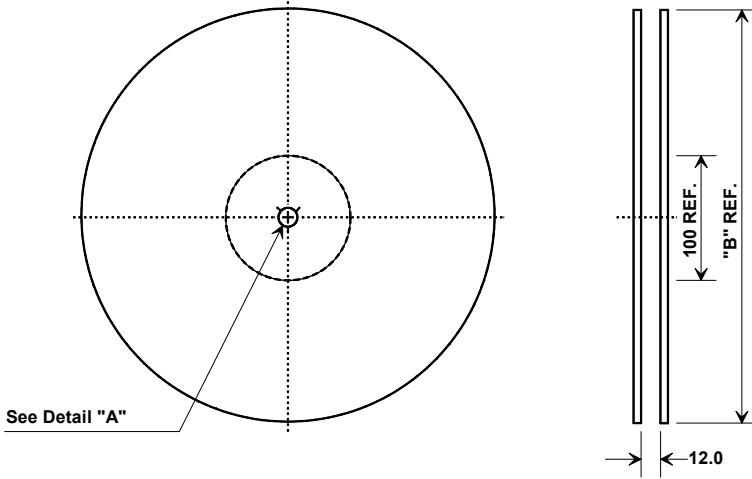

"B"		Quantity Per Reel
Inches	millimeters	
7	178	500
13	330	3000

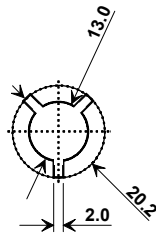

### COMPONENT ORIENTATION and DIMENSIONS

Carrier Tape Dimensions	
Ao	3.35 mm
Bo	3.35 mm
Ko	1.40 mm
Pitch	8.0 mm
W	12.0 mm

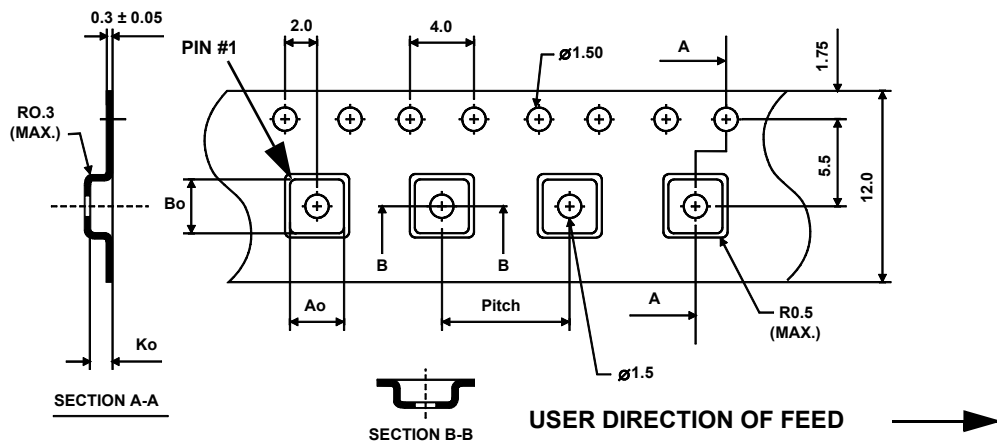

## Recommended Reflow Profile

1. Preheating shall be fixed at 150~180°C for 60~90 seconds.
2. Ascending time to preheating temperature 150°C shall be 30 seconds min.
3. Heating shall be fixed at 220°C for 50~80 seconds and at 260°C +0/-5°C peak (10 seconds).
4. Time: 5 times maximum.

