

MLX90397

3D magnetometer

Datasheet

Features and Benefits

- **3-axis** magnetometer device suitable for position sensors applications Triaxis® (Hall Technology)
- Suitable for space constrained applications (only 2 x 2,5 x 0.4mm)
- Compatible with I²C (0.1, 0.4, 1.0 MHz)
- Low power application – Power-down mode current of 7nA
- Supply voltage from 1.7V to 3.6V
- Ambient temperature range from -40°C to 105°C
- Digital Output
 - 16-bit Magnetic (XYZ)
 - 16-bit Temperature
- At runtime selectable modes
 - Magnetic axis selection
 - Single Measurement
 - Continuous Mode up to 1.4kHz (XYZ)
 - Power-Down mode
- RoHS Compliant & Green Package

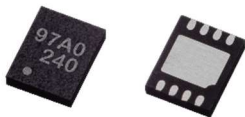

UTDFN-8

Application Examples

- Battery powered applications
- Power tools - Screwdriver trigger
- Home security - door/ window opening detection
- Knobs for white goods
- PC peripheral - Mouse roller
- Gaming pads
- Joystick with back-bias magnet
- Industrial pneumatic cylinder

Description

The device measures magnetic fields along the 3 axis and is specifically designed for micro-power applications. Those measurements and the IC temperature are transferred upon request over I²C communication channel. The device transmits compensated raw measurement data of the selected Bx, By, Bz or a combination.

The MLX90397 is designed for position sensor applications with a $\pm 50\text{mT}$ range and an adaptive range on Bz of $\pm 200\text{mT}$.

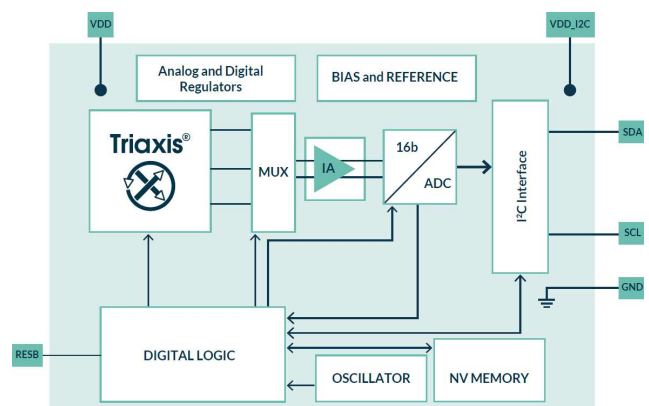

1. Ordering Information

Ordering Code	Temperature	Package	Type	Output	Packing	Definition
MLX90397RLQ-AAA-000-RE	-40°C to 105°C	UTDFN-8 2x2.5	±50mT	I ² C	Reel	I ² C address = 0x0D
MLX90397RLQ-AAA-001-RE	-40°C to 105°C	UTDFN-8 2x2.5	±50mT	I ² C	Reel	I ² C address = 0x2F

Table 1: Ordering codes

Legend:

MLX90397RLQ-AAA-000-RE

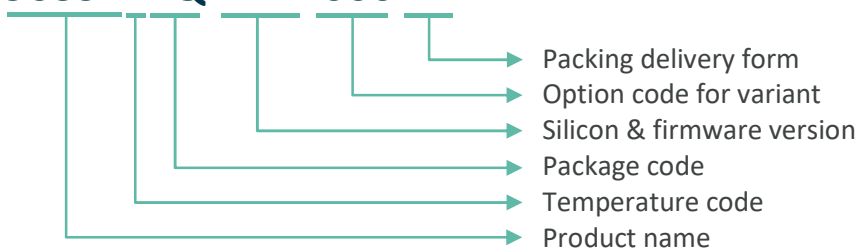

2. Contents

FEATURES AND BENEFITS.....	1
APPLICATION EXAMPLES.....	1
DESCRIPTION	1
1. ORDERING INFORMATION	2
2. CONTENTS	3
3. GLOSSARY OF TERMS.....	5
4. PINS DESCRIPTION AND BLOCK DIAGRAM	6
4.1. Pins Description	6
4.2. Block Diagram	6
5. CONDITIONS AND SPECIFICATIONS.....	7
5.1. Absolute Maximum Ratings (AMR)	7
5.2. Operating Conditions	8
5.2.1. General Operating Conditions.....	8
5.2.2. Electrical Operating Conditions.....	8
5.2.3. Magnetic Operating Conditions	8
5.3. Electrical Specifications.....	9
5.4. Magnetic Specifications	13
5.5. Timing Specifications	14
5.6. Accuracy Specifications.....	17
6. FUNCTIONAL DESCRIPTION & INTERFACES	18
6.1. Operating Modes	18
6.1.1. Single Measurement Mode	19
6.1.2. Continuous Measurement Mode	20
6.1.3. Power-Down Mode	24
6.2. Measurement Axis Selection.....	25
6.3. Magnetic Range Selection.....	25
6.4. Output Protocol (I ² C) Description	25
6.4.1. Command implementation.....	26
6.5. Memory Items Description	29
6.5.1. Memory Structure.....	29
6.5.2. I/O Registers Description	30
6.6. Flowchart	36
6.7. Noise Performance Graphs	37
6.7.1. Without temperature compensation.....	37
6.7.2. With temperature compensation	39
6.8. Temperature Compensation.....	41
7. APPLICATION INFORMATION	42
Recommended application diagram	42
8. PACKAGE AND MANUFACTURABILITY INFORMATION.....	43
8.1. ESD precaution.....	43
8.2. Package information – UTDFN8	43
8.2.1. Dimensions	43
8.2.2. Sensing element placement	44
8.2.3. Top Marking	44
8.3. Standard information on soldering processes	45
8.3.1. Storage and handling of plastic encapsulated ICs	45
8.3.2. Assembly of encapsulated ICs	45
8.3.3. Environment and sustainability.....	45
9. TABLES.....	46
10. FIGURES.....	47
11. REVISION HISTORY	48

12. DISCLAIMER49

3. Glossary of Terms

Term	Description
NC	Not Connected
ADC	Analog-to-digital converter
LSB	Least significant bit
MSB	Most significant bit
Gauss (G)	Units for magnetic flux density – 1mT = 10G
RMS	Root mean square
DSP	Digital signal processing

Table 2: Glossary of terms

4. Pins Description and Block diagram

4.1. Pins Description

Pin #	Name (I ² C)	Description
1	SCL	[I] Bus clock
2	Not used	Not Connected
3	V _{SS}	[S] Ground
4	SDA	[I/O] Bus Data
5	Not used	Not connected
6	V _{DD}	[S] Supply
7	RESB	[I] Reset
8	V _{DD_I2C}	[S] I/O supply

Table 3: Pin description

The exposed pad of the UTFDN-8 package can be left floating or shorted to ground.

4.2. Block Diagram

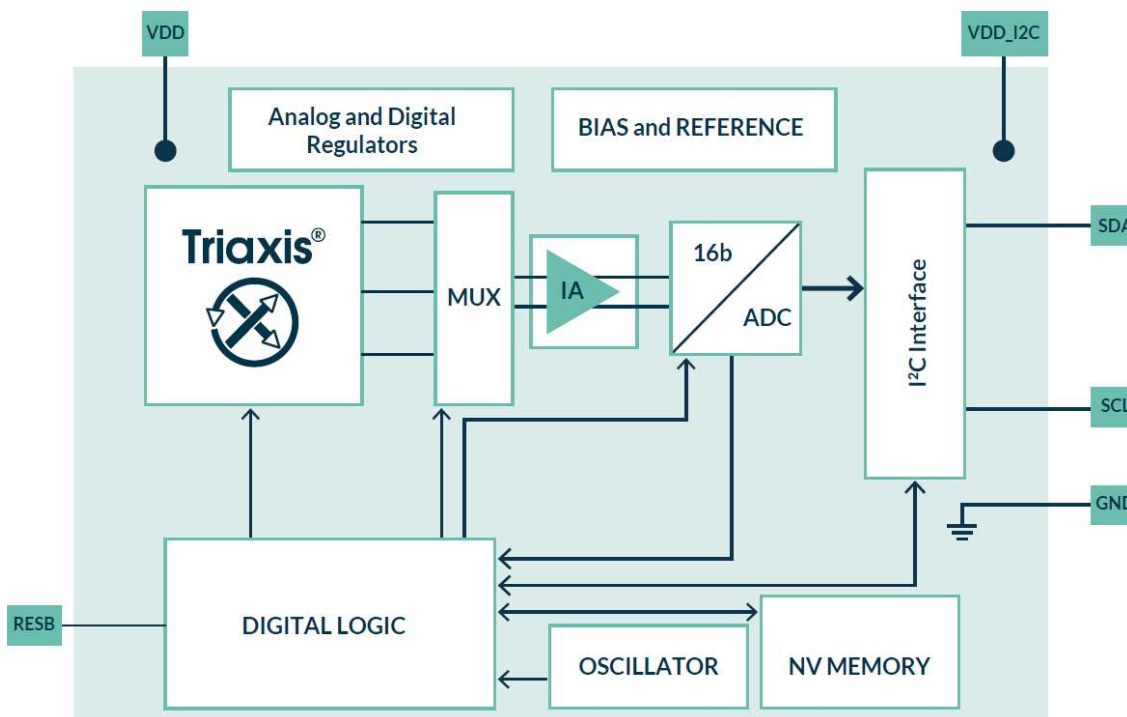

Figure 1: Block diagram

5. Conditions and Specifications

5.1. Absolute Maximum Ratings (AMR)

Operating characteristics, $T_A = -40^{\circ}\text{C}$ to 105°C (unless otherwise specified)

Parameter	Symbol	Min.	Typ.	Max.	Unit	Conditions
Supply voltage	V_{DD}			4	V	<48h
Reverse supply voltage protection	V_{DDREV}			-0.3	V	Room temp, <48h
Supply voltage I ² C	V_{DD_I2C}			4	V	<48h
Reverse I ² C supply voltage protection	V_{DDREV}			-0.3	V	Room temp, <48h
Output voltage	V_{SDA}			4	V	<48h
Reverse output voltage	V_{SDAREV}			-0.3	V	Room temp, <48h
Input voltage	V_{RESB}, V_{SCL}			4	V	<48h
Reverse input voltage	$V_{RESBREV}, V_{SCLREV}$			-0.3	V	typical Vdd operating range, room temp, <48h
Operating temperature	T_A	-40		+105	°C	
Junction temperature	T_{JUNC}			+105	°C	
Storage temperature	$T_{storage}$	-40		150	°C	
Thermal resistance	R_{thja}		230		°C/W	Junction to ambient 1s0p board
			40		°C/W	Junction to ambient multi layered pcb
Thermal resistance	R_{thjc}		3.4		°C/W	Junction to case
Magnetic flux density		-1		1	T	

Table 4: Absolute Maximum Ratings

Exceeding the absolute maximum ratings may cause permanent damage. Exposure to absolute maximum-rated conditions for extended periods may affect device reliability.

5.2. Operating Conditions

5.2.1. General Operating Conditions

Parameter	Symbol	Min.	Typ.	Max.	Unit	Conditions
Operating temperature	T _A	-40		105	°C	
Storage temperature	T _{storage}	-40		150	°C	

Table 5: General operating conditions

5.2.2. Electrical Operating Conditions

Parameter	Symbol	Min.	Typ.	Max.	Unit	Conditions
Supply voltage	V _{DD}	1.7	1.8	3.6	V	
I/O supply voltage	V _{DD_I2C}	1.7	1.8	3.6	V	

Table 6: Electrical operating conditions

5.2.3. Magnetic Operating Conditions

Parameter	Symbol	Min.	Typ.	Max.	Unit	Conditions
Magnetic flux density	B _{xy}	-50		50 ⁽¹⁾	mT	$B_{xy} = \sqrt{B_x^2 + B_y^2}$
Magnetic flux density	B _z	-200		200 ⁽²⁾	mT	B _z

Table 7: Magnetic operating conditions

¹ Above this value, the sensor starts saturating resulting in an increase of the linearity error.

² For magnetic ranges above 50mT, Melexis only guarantees the performance by design

5.3. Electrical Specifications

Operating characteristics, $T_A = -40^{\circ}\text{C}$ to 105°C (unless otherwise specified)

Parameter	Symbol	Min.	Typ.	Max.	Unit	Conditions
RESB high threshold		49	61	67	$\%V_{DD}$	$\pm 3\sigma$
RESB low threshold		41	50	51	$\%V_{DD}$	$\pm 3\sigma$
RESB hysteresis		5	11	17	$\%V_{DD}$	$\pm 3\sigma$
DSP current	$I_{DD,DSP}$	0.7 1	1 1.5	1.2 2	mA mA	$V_{DD} \leq 1.8\text{V}$ $V_{DD} > 1.8\text{V}$
Conversion current	$I_{DD,CONVXY}$ $I_{DD,CONVZ}$	2.4 2.8 3 3.4	2.9 3.4 3.8 4.4	3.5 4.5 5 6	mA mA mA mA	XY axis, $V_{DD} \leq 1.8\text{V}$ XY axis, $V_{DD} > 1.8\text{V}$ Z axis, $V_{DD} \leq 1.8\text{V}$ Z axis, $V_{DD} > 1.8\text{V}$
Conversion current	$I_{DD,CONVT}$	0.7 1.1	0.9 1.4	1 1.85	mA mA	Temperature, $V_{DD} \leq 1.8\text{V}$ Temperature, $V_{DD} > 1.8\text{V}$
Counting state current	$I_{DD,CNT}$	11 12	13 20	15 25	μA μA	$V_{DD} \leq 1.8\text{V}$ $V_{DD} > 1.8\text{V}$
Power-down current	$I_{DD,PD}$		7 400 25 600	30 1000 100 2000	nA nA nA nA	$V_{DD} = 1.8\text{V}$, $T_A = 35^{\circ}\text{C}$ $V_{DD} = 1.8\text{V}$, $T_A = 105^{\circ}\text{C}$ $V_{DD} = 3.6\text{V}$, $T_A = 35^{\circ}\text{C}$ $V_{DD} = 3.6\text{V}$, $T_A = 105^{\circ}\text{C}$
Temperature sensor resolution ⁽³⁾	T_{RES}	48	50	52	LSB16/ $^{\circ}\text{C}$	
Temperature sensor accuracy	T_{LIN}	-3		3	$^{\circ}\text{C}$	$\pm 3\sigma$
Input level high ⁽⁴⁾	V_{IH}	53	65	71	$\%V_{DD,I2C}$	SDA, SCL
Input level low ⁽⁴⁾	V_{IL}	37	49	54	$\%V_{DD,I2C}$	SDA, SCL
Input level hysteresis ⁽⁴⁾	V_{IHYST}	9	16	21	$\%V_{DD,I2C}$	SDA, SCL
Input capacitance ⁽⁴⁾	C_{in}		8	15	pF	SDA, SCL
Output level low	V_{OL}	2	4	6	mV	SDA (Static, 1mA load)
Output on resistance	R_{dson}	2	4	6	Ω	$\pm 3\sigma$
Output leakage current			0.1	0.3	μA	
ESD HBM				1	kV	All pins
ESD CDM				0.5	kV	All pins

³ The data format is 2's complement with 0 LSB16 corresponding to 0°C

⁴ This specification relates to the sensor and not the I²C bus

Parameter	Symbol	Min.	Typ.	Max.	Unit	Conditions
Average current 100Hz refresh	$I_{DD,AVG100-1}$	0.6 0.8	0.8 1	1 1.3	mA mA	Continuous mode TXYZ, OSR_HALL=1 DIG_FILTERXY=2 DIG_FILTERZ=3 DIG_FILTER_TEMP=1 OSR_TEMP=1 Temp Comp enabled Tconv = 2.76ms VDD ≤ 1.8V VDD > 1.8V
Average current 125Hz refresh	$I_{DD,AVG125-1}$	170 200	270 320	340 430	μA μA	Continuous mode XZ or YZ measured only, OSR_HALL=1 DIG_FILTERXY=0 DIG_FILTERZ=1 Temp Comp disabled Tconv = 707μs VDD ≤ 1.8V VDD > 1.8V
Average current 125Hz refresh	$I_{DD,AVG125-1}$	220 270	320 400	390 530	μA μA	Continuous mode TXZ or TYZ measured only, OSR_HALL=1 DIG_FILTERXY=0 DIG_FILTERZ=1 DIG_FILTER_TEMP=1 OSR_TEMP=1 Temp Comp enabled Tconv = 1.18ms VDD ≤ 1.8V VDD > 1.8V
Average current 125Hz refresh	$I_{DD,AVG125-1}$	160 190	200 250	250 330	μA μA	Continuous mode XY measured only, OSR_HALL=1 DIG_FILTERXY=0 Temp Comp disabled Tconv = 600μs VDD ≤ 1.8V VDD > 1.8V

Table 8: Electrical Specifications

5.3.1.1. Average consumption

Average current consumption vs. Filtering - Continuous measurement mode (10, 20, 50, 100, 125, 200, 500Hz)
 Conditions: XYZ+T measurements, OSR_HALL=1, Temp compensation on

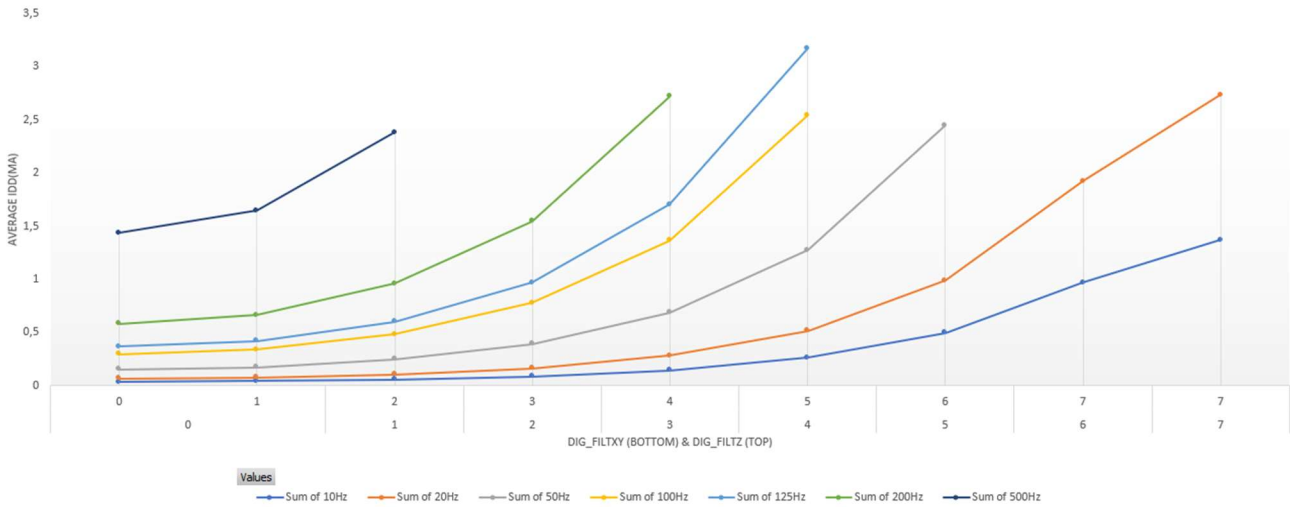

Figure 2: Average Consumption vs Filtering – Continuous measurement mode - Temperature compensation on

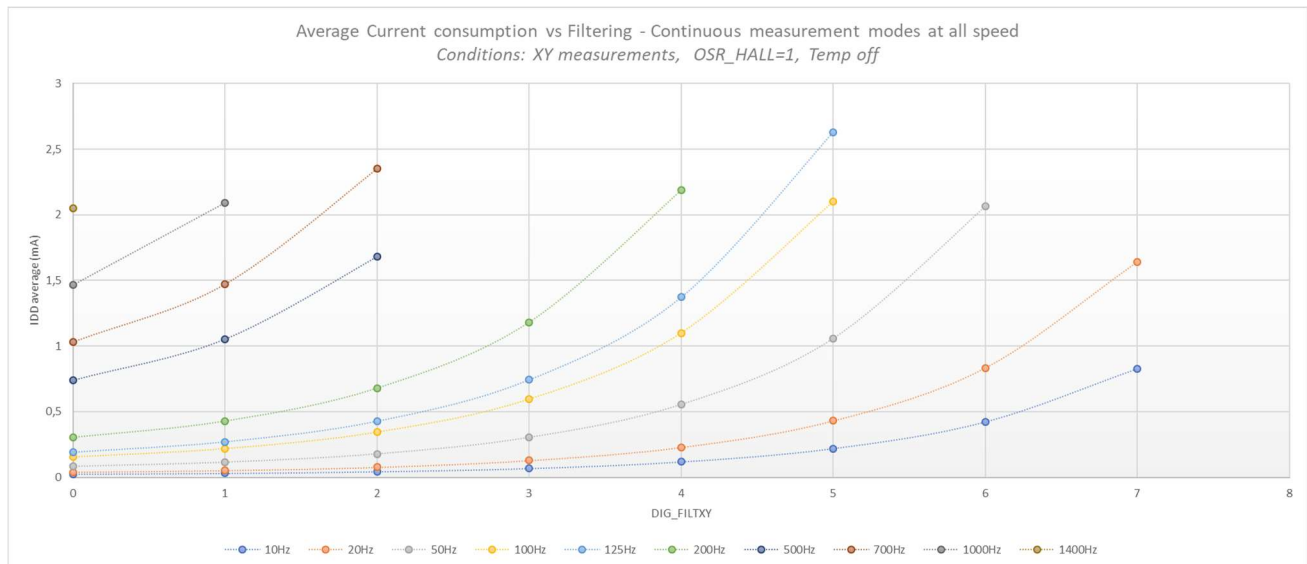

Figure 3: Average Consumption vs Filtering – Continuous measurement at all possible speeds – Temp compensation off



Figure 4: Average consumption vs Filtering – Continuous measurements at 10Hz – Temperature compensation off

Average current consumption calculation

$$T_{DSP} = f(T_COMP_EN, \text{Number_Enabled_Magnetic_Axes})$$

$$T_{refresh} = \frac{1}{F_{refresh}}$$

$$T_{CNT} = T_{refresh} - (T_COMP_EN \cdot T_{CONV_T} + X_EN \cdot T_{CONV_XY} + Y_EN \cdot T_{CONV_XY} + Z_EN \cdot T_{CONV_Z} + T_{DSP})$$

$$I_{DD_AVG} = \frac{T_COMP_EN \cdot T_{CONV_T} \cdot I_{DD_CONV_T} + X_EN \cdot T_{CONV_XY} \cdot I_{DD_CONV_XY} + Y_EN \cdot T_{CONV_XY} \cdot I_{DD_CONV_XY} + Z_EN \cdot T_{CONV_Z} \cdot I_{DD_CONV_Z} + T_{DSP} \cdot I_{DD_DSP} + T_{CNT} \cdot I_{DD_CNT}}{T_{refresh}}$$

5.4. Magnetic Specifications

Operating characteristics, $T_A = -40^{\circ}\text{C}$ to 105°C (unless otherwise specified)

Parameter	Symbol	Min.	Typ.	Max.	Unit	Conditions
XY Magnetic sensitivity	SENS _{XY_25}	0.675	0.75	0.825	μT/LSB16	room temperature, 25mT range
	SENS _{XY_50}	1.35	1.5	1.65	μT/LSB16	50mT range
Z Magnetic sensitivity	SENS _{Z_25}	0.675	0.75	0.825	μT/LSB16	room temperature, 25mT range
	SENS _{Z_50}	1.35	1.5	1.65	μT/LSB16	50mT range
	SENS _{Z_100}	2.7	3	3.3	μT/LSB16	100mT range
	SENS _{Z_200}	5.4	6	6.6	μT/LSB16	200mT range
Magnetic measurement range XY	B _{RANGE_XY_25}	±22,107	±24,564	±27,020	μT	room temperature, 25mT range
	B _{RANGE_XY_50}	±44,215	±49,128	±54,041	μT	50mT range
Magnetic measurement range Z	B _{RANGE_Z_25}	±22,107	±24,564	±27,020	μT	room temperature, 25mT range
	B _{RANGE_Z_50}	±44,215	±49,128	±54,041	μT	50mT range
	B _{RANGE_Z_100}	±88,430	±98,256	±108,082	μT	100mT range
	B _{RANGE_Z_200}	±176,860	±196,512	±216,163	μT	200mT range
RMS noise ⁽⁵⁾	N _{XYZ}		1.90	2.20	μTrms	without temperature compensation 5ms conv time DIG_FILTXY=3 DIG_FILTZ=4, OSR_HALL=1, room temperature 25mT range 50mT range
			2.40	2.80		
RMS Noise ⁽⁵⁾	N _{XYZ}		2.00	2.30	μTrms	with temperature compensation 5ms conv time (DIG_FILTXY=3 DIG_FILTZ=4, OSR_HALL=1), room temperature 25mT range 50mT range
			2.90	3.50		
Sensitivity drift vs $T_A = 35^{\circ}\text{C}$	SENS _{THD}	-5		5	%	With temperature compensation
		-8		8	%	Without temperature compensation
Hysteresis	B _h	200			μT	

Table 9: Magnetic Specifications

⁵ Not validated by any production test, only verified by characterization

5.5. Timing Specifications

Operating characteristics, $T_A = -40^{\circ}\text{C}$ to 105°C (unless otherwise specified)

Parameter	Symbol	Min.	Typ.	Max.	Unit	Conditions
Output refresh rate ⁽⁶⁾	Fr1	10	100	700	Hz	With temperature measurement ⁽⁷⁾
	Fr2			1400	Hz	Without temperature measurement ⁽⁶⁾
Oscillator trimming accuracy	TOSC_TRIM	-5	0	5	%	room temperature
Oscillator thermal drift	TOSC_THD	-5	0	5	%	
Magnetic axis/Temperature conversion time ⁽⁸⁾	T _{CONV}	105.8	113.3	121.9	μs	Time per axis DIG_FILT=0, OSR=0
	T _{CONV}	205.5	220.0	236.7	μs	Time per axis DIG_FILT=0, OSR=1
	T _{CONV}	902.8	966.7	1040.2	μs	Time per axis DIG_FILT=3, OSR=1
	T _{CONV}	12857.5	13766.7	14814.2	μs	Time per axis DIG_FILT=7, OSR=1
Start-up time	T _{Startup}		0.15	1.2	ms	Reset to power-down mode
Manual reset	T _{RES}	3	5		μs	Minimum time to trigger a reset V _{dd} >1.7V
DSP Time	T _{DSP}	359.9	385.4	414.7	μs	XYZ enabled ⁽⁶⁾
		223.0	238.8	256.9	μs	XYZ enabled ⁽⁶⁾

Table 10: Timing specifications

⁶ Fr1 and Fr2 are defined as the period between two set of measurements. It is relevant for the Continuous measurement mode and is defined by the parameter MODE[3:0]. TREFRESH is adjustable with the following settings: 10Hz, 20Hz, 50Hz, 100Hz, 125Hz, 200Hz, 500Hz, 700Hz, 1000Hz, and 1.4kHz. The default value in the non-volatile memory is 100Hz.

⁷ The temperature compensation can be enabled or disabled by the user.

⁸ This conversion time is defined as the time to acquire a single axis of the magnetic flux density. When measuring XYZ, they are obtained through time-multiplexing. The conversion time is programmable through DIG_FILT for magnetic and temperature conversion. The total conversion time is obtained by summing up the magnetic & temperature conversion time.

5.5.1.1. **Magnetic Axis/ Temperature Conversion time**

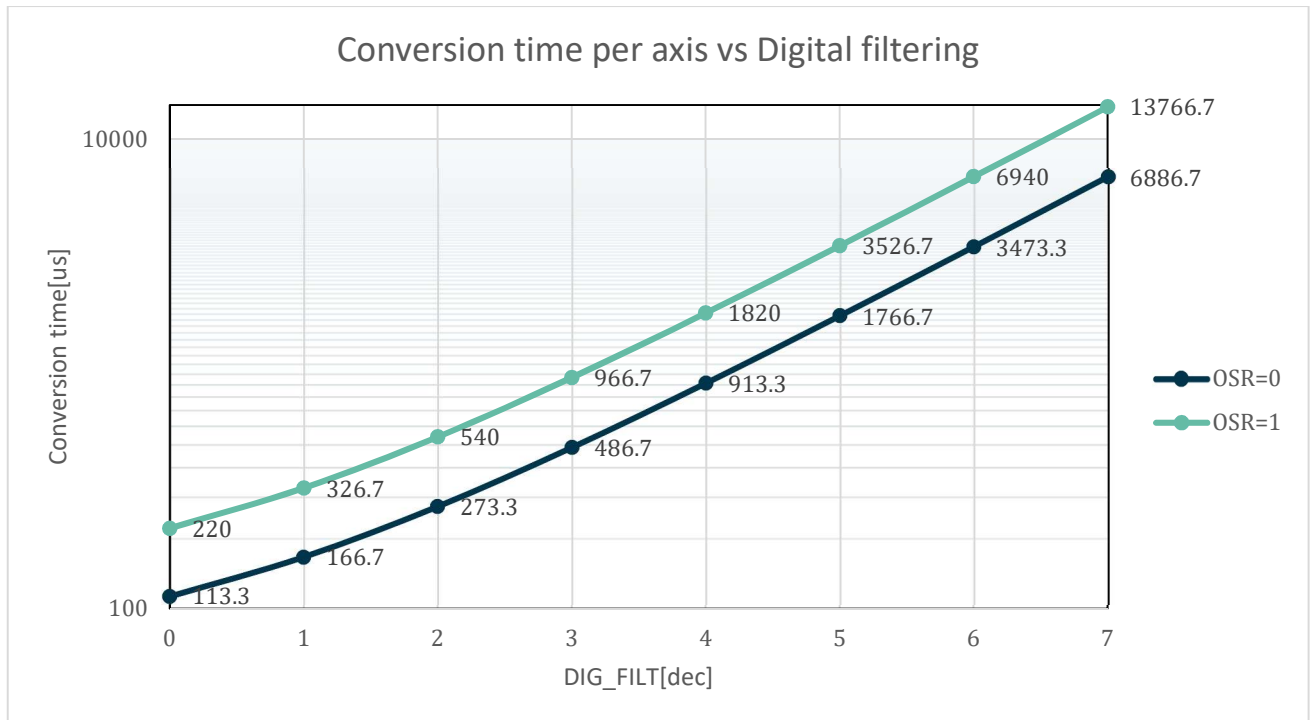

Figure 5: Conversion time vs. digital filtering (DIG_FILT) at typical Fclk = 2.4MHz

The above graph can be expressed with the following formula ($F_{clk} = 2.4MHz$ typically):

$$T_{CONV}(OSR, DIG_FILT) = \frac{16 + 2^{(OSR+5)} \cdot (2^{(DIG_FILT+2)} + 4)}{F_{clk}}$$

5.5.1.2. DSP Time

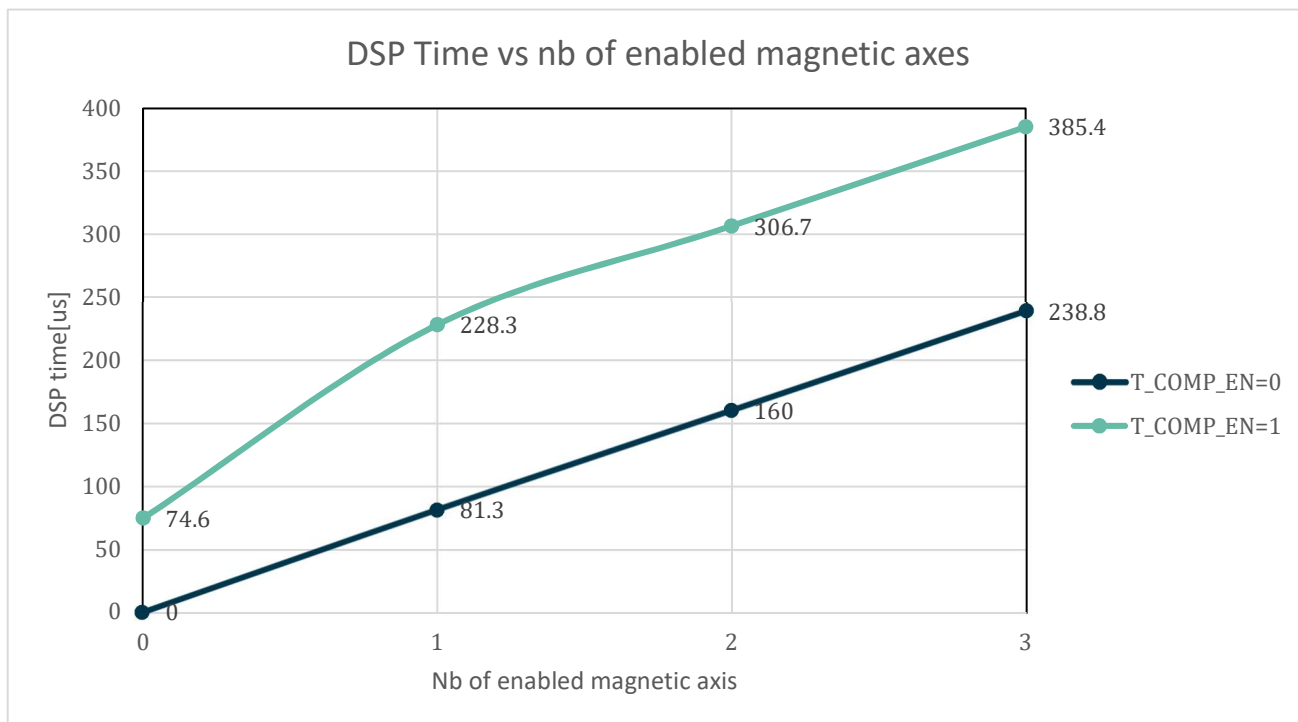

Figure 6: DSP time vs. number of enabled magnetic axes at typical Fclk = 2.4MHz.

5.5.1.3. Reset sequence

The MLX90397 does not embark a Power on Reset. The reset should be performed by the user using the RESB external pin. Melexis recommends to follow the below timings:

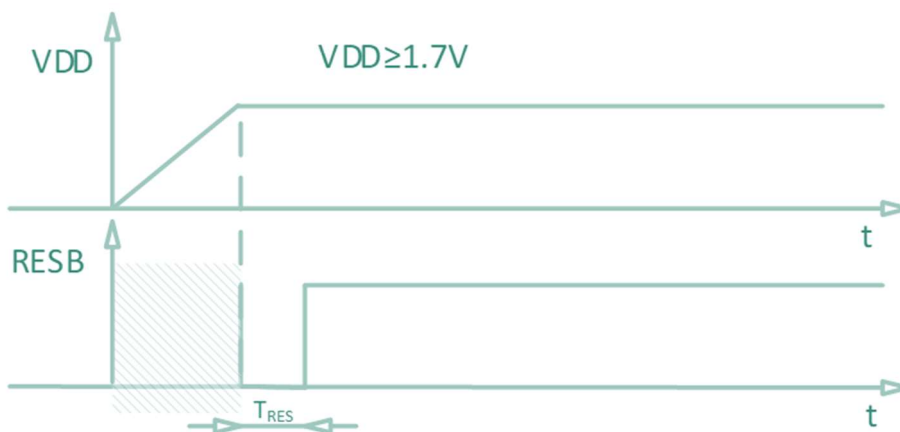

Figure 3: Reset sequence

5.6. Accuracy Specifications

Operating characteristics, $T_A = -40^{\circ}\text{C}$ to 105°C (unless otherwise specified). All specifications in this chapter are given with ± 3 sigma.

Parameter	Symbol	Min.	Typ.	Max.	Unit	Conditions
Resolution ⁽⁹⁾			16		bits	XYZ
Offset ⁽¹⁰⁾	O _{FFSX} O _{FFSY} O _{FFSZ}	-200 -200 -200		200 200 200	μT	at 0 Gauss, Room temperature, Ranges 25mT and 50mT
Offset thermal drift X-axis Offset thermal drift Y-axis Offset thermal drift Z-axis		-100 -100 -100		100 100 100	μT	vs. $T_A = 35^{\circ}\text{C}$
Sensitivity mismatch	S _{MISMXY} S _{MISMZ} S _{MISMYZ}	-1.5 -3 -5.1	2.1 1.7 -0.8	5.7 6.4 3.5	% % %	
Thermal drift of sensitivity mismatch		-200		200	ppm/ $^{\circ}\text{C}$	
Cross-axis sensitivity ⁽¹¹⁾	S _{XYi} S _{YXi} S _{XZi} S _{ZXi} S _{YZi} S _{ZYi}	-5 -3.9 -5.1 -2.4 -4 -3.8	-0.3 0.6 -2.1 -0.2 0.9 0.7	4.4 5.1 0.9 2 5.8 5.2	% % % % % %	verified by characterization / not by final testing
Non-linearity		-0.3 -0.1 -0.4 -0.2		0.3 0.1 0.4 0.2	%FS %FS %FS %FS	DIG_FILT = 7. Best fit method Verified by characterization only. XY, range 25mT Z, range 25mT XY, range 50mT Z, range 50mT

Table 11: Accuracy specifications

⁹ The data format is 2's complement, further explanation can be found on [Table 14: Magnetic data format](#)

¹⁰ Value of measurement data register on shipment test without applying magnetic field on purpose. These values are guaranteed in the operating magnetic field range.

¹¹ The cross axis sensitivity is measured by applying a force field on one axis and measured on another axis. For instance, S_{XYi} means that a field was applied along X axis and measured along Y axis.

6. Functional Description & Interfaces

6.1. Operating Modes

MLX90397 has the following Application modes

1. Power-down mode
2. Single measurement mode
3. Continuous measurement mode (10Hz, 20Hz, 50Hz, 100Hz, 125Hz, 200Hz, 500Hz, 700Hz, 1000Hz, and 1.4kHz)

Operating Mode	Start of Mode	End of Mode (Return to power-down)	Measurement Data
Single measurement	Command to enter mode 1 or 9	Measurement finished	(T)XYZ
Continuous mode	Command to enter mode 2, 3, 4, 5, 6, 10, 11, 12, 13, 14	Transition to other mode	(T)XYZ
Power-down Mode	Power up or command to enter mode 0, 8, 15	Transition to other mode	-

Table 12: Operating modes

Note: To change an operating mode, the sensor should be first in power-down mode.

6.1.1. Single Measurement Mode

When the *Single measurement mode* is set, a magnetic measurement is started. After a measurement and when the signal processing is finished, the measurement data is stored to the data registers (**X**, **Y** and **Z**). After this, the sensor will go to the *power-down mode* automatically.

While going to the *power-down mode*, **MODE[3:0]** bits turn to 0. At the same time, **DRDY** bit (Data Ready) in **STAT1** register turns to High.

When any of measurement data register (**X**, **Y** and **Z**) is read, **DRDY** bit turns to Low. It remains High when switching from *power-down mode* to another mode.

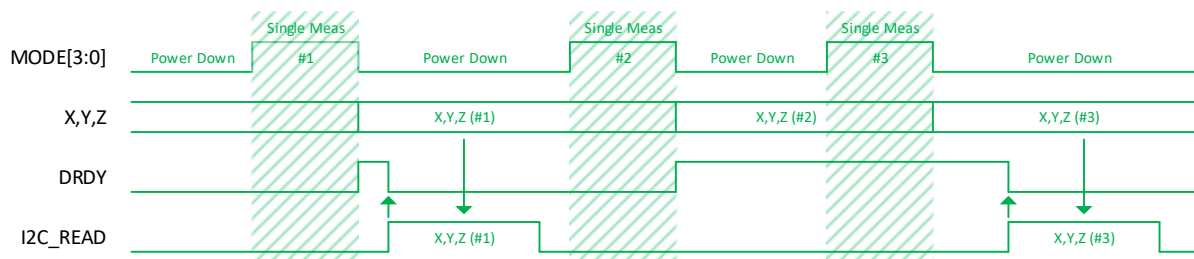

Figure 7: Single measurement mode when data is read out of measurement period

When the sensor is measuring, the data registers (**X**, **Y** and **Z**) keep the previous data. Therefore, it is possible to read out data even during measurement periods.

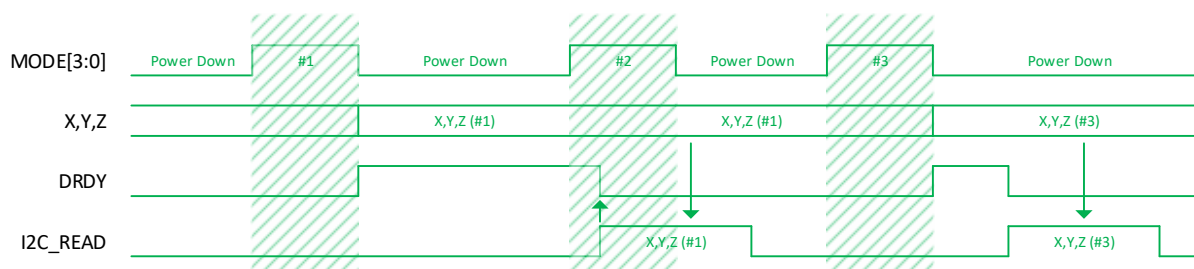

Figure 8: Single measurement mode when data read started during measurement period

6.1.2. Continuous Measurement Mode

When the "Continuous measurement" mode is set, the measurement starts periodically. After measurement and signal processing is finished, the measurement data is stored to the data registers (**X**, **Y**, and **Z**). Almost all internal blocks are disabled ("Counting" power state).

After a measurement period, **the device** wakes up automatically from "Counting" power state and starts a new measurement.

The Continuous measurement mode ends when "power-down" mode (**MODE[3:0]** bits = 0) is set. If the measurement period is changed while **the device** is already configured in "Continuous measurement" mode, a new measurement starts.

STAT1 and measurement data registers (**X**, **Y** and **Z**) will not be initialized by this.

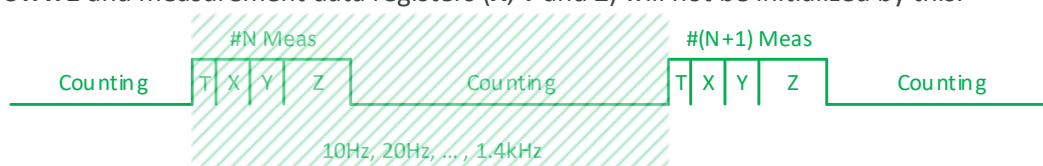

Figure 9: Continuous measurement mode

6.1.2.1. Data Ready

When the measurement data is stored and ready to be read, the **DRDY** bit (Data ready) in **STAT** register is set to High. When a measurement is performed correctly, the device sets the Data Ready bit before going back to "Counting" power state.

6.1.2.2. Normal Read Sequence

The stored measurement data is protected during the data reading. There is no update of the data during this time. Consequently, the following sequence should be followed:

1. **Check if the Data is Ready or not** by polling **DRDY** bit of **STAT1** register
 - a. **DRDY**: Data Ready. The Data is ready when set High.
2. Reading of the **STAT1** register will not trigger the protection.
3. **Read measurement data** - When **any of** the measurement data register (**X**, **Y**, or **Z**) is read, the device enables the protection as soon as the register is copied into the I²C sending register. When data reading starts, **DRDY (Data ready)** bit turns Low.
4. **Read STAT2 register (required for data consistency - provides information on overflow and data skip)**

When this read sequence is followed and there is no attempted I²C read during measurement, reading of **STAT2** sets the **DOR** bit to low (see I/O registers description for reference).

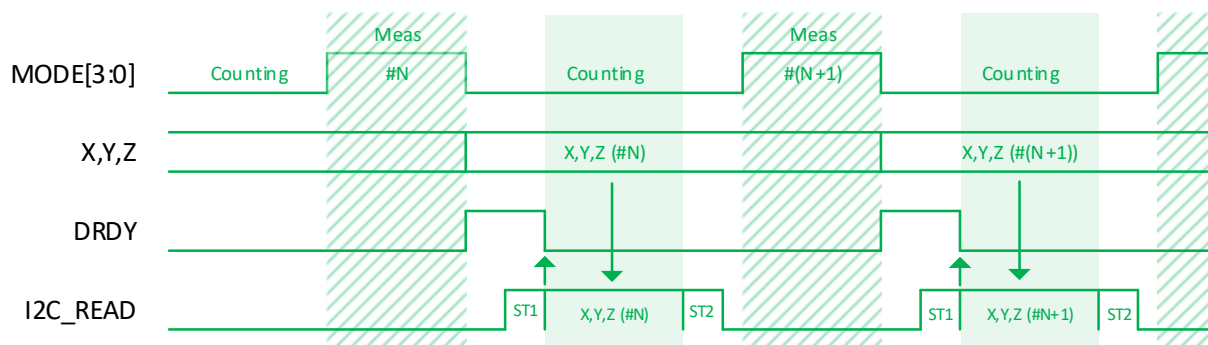

Figure 10: Normal read sequence

6.1.2.3. Data Read Start During Measurement

When the sensor is measuring, the measurement data registers (**X**, **Y** and **Z**) keep the previous data. Therefore, it is possible to read out data even in measurement period.

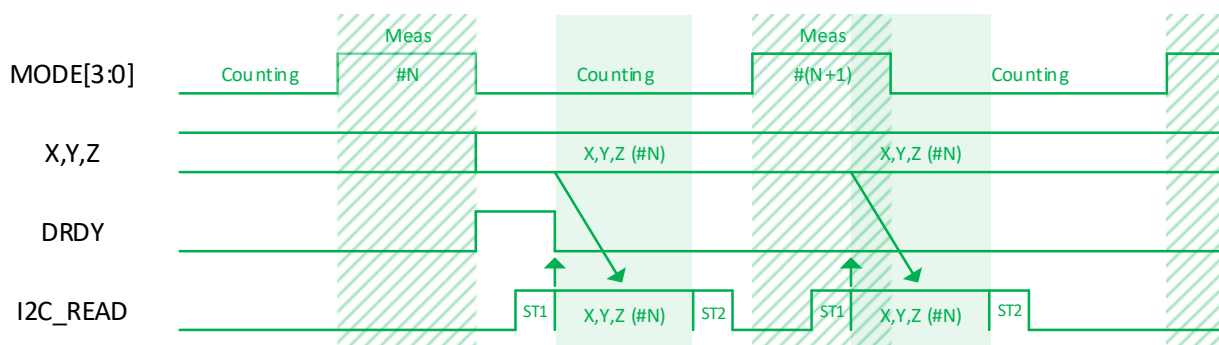

Figure 11: Data read start during measurement

6.1.2.4. Timing Considerations

The device offers many options for different axis configurations depending on the tradeoff between:

- noise-measurement time
- current consumption
- temperature compensation
- axis selection

Whichever settings are chosen depending on the application specific requirements, the following timing consideration should be always considered during design in order to ensure proper continuous measurement mode operation:

$$T_{\text{CONV_TEMP}} + T_{\text{CONV_X}} + T_{\text{CONV_Y}} + T_{\text{CONV_Z}} + T_{\text{DSP}} + 66\mu\text{s} < 1/\text{Fr}$$

Example 1:

The lowest possible noise and temperature compensation of XYZ magnetic sensitivities at refresh rate of 100Hz (10,000 μs period) result in the following settings:

- OSR_HALL = OSR_TEMP = 1b, DIG_FILT_XY = 6d, DIG_FILT_TEMP = 1d
- Temperature compensation enabled, DIG_FILT_Z = 7d
- X, Y, Z enabled, MODE[3:0] = 5h (100Hz)

Referring to the timing specifications and the inequality, for the selected settings follows:

$326.7\mu\text{s} + 6,940.0\mu\text{s} + 6,940.0\mu\text{s} + 13,766.7\mu\text{s} + 385.4\mu\text{s} + 66\mu\text{s} < 10,000\mu\text{s} \rightarrow$ The criterion is not satisfied because the selected refresh rate is not slow enough.

Example 2:

The lowest possible noise and temperature compensation of XYZ magnetic sensitivities at refresh rate of 20Hz (50,000 μs period) result in the following settings:

- OSR_HALL = OSR_TEMP = 1b, DIG_FILT_XY = 6d, DIG_FILT_TEMP = 1d
- Temperature compensation enabled, DIG_FILT_Z = 7d
- X, Y, Z enabled, MODE[3:0] = 3h (20Hz)

Referring to the timing specifications and the inequality for the selected settings follows:

$326.7\mu\text{s} + 6940.0\mu\text{s} + 6940.0\mu\text{s} + 13766.7\mu\text{s} + 385.4\mu\text{s} + 66\mu\text{s} < 50,000\mu\text{s} \rightarrow$ The criterion is satisfied.

Refresh rate	10Hz	20Hz	50Hz	100Hz	125Hz	200Hz	500Hz	700Hz	1KHz	1.4KHz
Measurements	TXYZ	TXYZ	TXYZ	TXYZ	TXYZ	TXYZ	TXYZ	TXYZ	XY	XY
T_COMP_EN (binary)	1	1	1	1	1	1	1	0	0	0
OSR_HALL (binary)	1	1	1	1	1	1	1	1	1	0
OSR_TEMP (binary)	1	1	1	1	1	1	1	N/A	N/A	N/A
DIG_FILT_TEMP (decimal)	6	1	1	1	1	1	1	N/A	N/A	N/A
DIG_FILT_HALL_XY (decimal)	6	6	5	4	3	2	0	0	0	1
DIG_FILT_HALL_Z, (decimal)	7	7	6	5	4	3	1	1	N/A	N/A

Table 13: Example of settings satisfying the timing consideration for proper operation in continuous measurement mode

6.1.2.5. Data Skip

If the available data is not read before a new measurement ends, the DRDY bit (Data Ready) remains High. However, a new set of measurement data will replace the previous one.

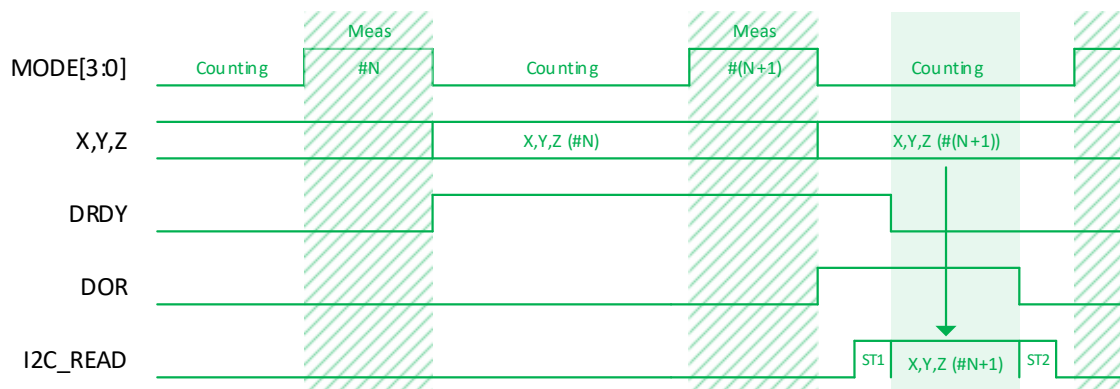

Figure 12: Data Skip: When data is not read

If the available data is read while a new measurement is being performed, this set of data will be protected. This is also the case even if the reading procedure finishes after the measurement. Consequently, this new set of data is skipped.

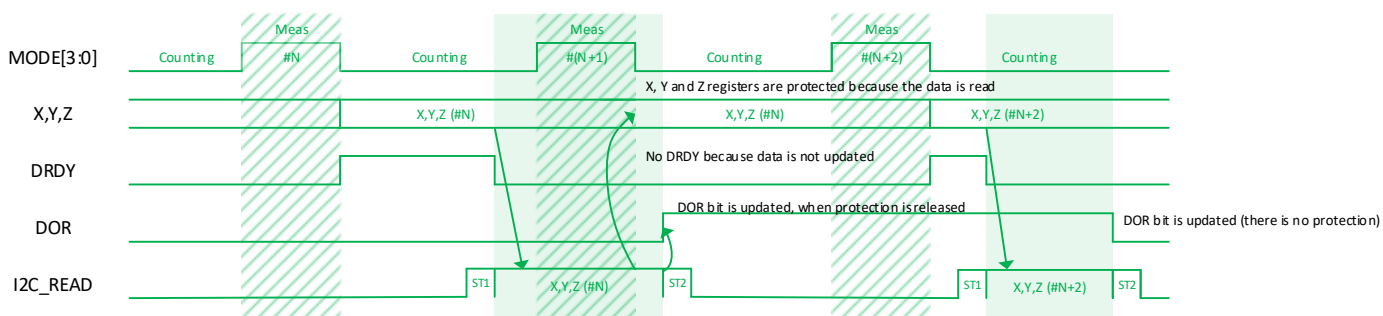

Figure 13: Data Skip: When data read has not been finished before the next measurement end

6.1.2.6. End Operation

Set the power-down mode (**MODE[3:0]** bits = **0**) to end the Continuous measurement mode.

6.1.2.7. Magnetic Sensor Overflow

The device has two separate limitations for measurement range. Combined for X and Y axes and another one for Z axis. The absolute values of X and Y axis should be smaller than 25mT or 50mT depending on the selected range.

Along Z axis, the absolute value should be smaller than 25mT, 50mT, 100mT or 200mT depending on the selected range.

X, Y, Z (2's complement)	X, Y, Z (HEX)	X, Y, Z (Decimal)	Range = 25mT [μ T]	Range = 50mT [μ T]	Range = 100mT [μ T]	Range = 200mT [μ T]
0111 1111 1111 0000	7FF0	32,752	24,564	49,128	98,256	196,512
0000 0000 0000 0001	0001	1	0.75	1.50	3.00	6.00
0000 0000 0000 0000	0000	0	0	0	0	0
1111 1111 1111 1111	FFFF	-1	-0.75	-1.50	-3.00	-6.00
1000 0000 0001 0000	8010	-32,752	-24,564	-49,128	-98,256	-196,512

Table 14: Magnetic data format

When the magnetic field exceeds the limitation, data stored at measurement data are not correct. This is called Magnetic Sensor Overflow.

For X axis overflow flag condition is: $|X| > 32,752$

When the condition is performed, HOFL_X bit turns to "1".

For Y axis overflow flag condition is: $|Y| > 32,752$

When the condition is performed, HOFL_Y bit turns to "1".

For Z axis overflow check is: $|Z| > 32,752$ If the condition is fulfilled, the HOFL_Z bit turns to "1".

When measurement data register (X, Y and Z) is updated, HOFL_X, HOFL_Y and HOFL_Z bits are updated, too

6.1.3. Power-Down Mode

In power-down mode, the device is in minimal power consumption state. All internal blocks are disabled. Only the communication over the I²C interface is maintained. The digital handling of the communication is clocked by the I²C master clock. All registers remain accessible and the data stored in read/write registers remains.

6.2. Measurement Axis Selection

Each measurement axis (i.e X, Y or Z) can be selected and then measured individually or through a combination of 2 or 3 axis.

This is user configurable through the CTRL register. See chapter 6.5.2.7 for more details.

6.3. Magnetic Range Selection

The magnetic range is controlled through the RANGE_SEL parameter.

RANGE_SEL[2:0]	X & Y ranges [mT]	Z range [mT]
0	25	25
1	50	25
2	25	50
3 (default)	50	50
4 ⁽¹²⁾	25	100
5 ⁽¹²⁾	50	100
6 ⁽¹²⁾	25	200
7 ⁽¹²⁾	50	200

Table 15: XY and Z magnetic range selection

6.4. Output Protocol (I²C) Description

The 7-bit I²C address is pre-programmed to a fixed value of 0x0D. This value cannot be changed by the user. Please contact Melexis in case a specific address is needed.

Description	7-bits I ² C address	R/W bit
bits	7-1	0
value	0x0D or 0b0001101	0 for I ² C write 1 for I ² C read

Table 16: 8-bits Addressing register

¹² For magnetic ranges above 50mT, Melexis only guarantees the performance by design

6.4.1. Command implementation

The following I²C commands are implemented:

- **MEM_DIRECT_READ**: reads data from memory space, starting from the default address 0x00
- **MEM_READ**: the start address will be specified in the command and the address will be incremented for continuous reading until an I²C stop is detected.
- **MEM_WRITE**: the start address will be specified followed by the data to be stored at addresses starting from the given start address and incremented until an I²C stop is detected.
- **ADDRESSED_RESET**: reset of the device, based on the I²C Slave Address (reset of addressed devices on the I²C bus only)

In the next sections, the format of the different I²C commands is explained.
The following legend is used:

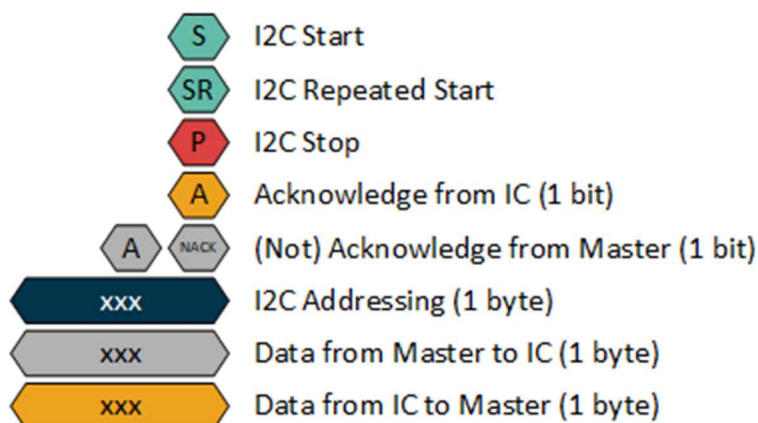

6.4.1.1. Read Commands

There are two read commands that are implemented

- **MEM_DIRECT_READ:** reads data from memory space, starting from the default address 0x00
- **MEM_READ:** the start address will be specified in the command and the address will be incremented for continuous reading until an I²C stop is detected.

6.4.1.1.1. MEM_DIRECT_READ (direct read) Command

MEM_DIRECT_READ: reads data from memory space, starting from the default address 0x00



Figure 14: I²C - MEM_DIRECT_READ (direct read) Command

NOTES:

- Incremental readout – return 0x00 when address out of valid space
- **NAK is needed from master** to allow going to STOP

6.4.1.1.2. MEM_READ (addressed read)

MEM_READ: the start address will be specified in the command and the address will be incremented for continuous reading until an I²C stop (P) is detected.

Incremental read-out starting at a given address (Register Start Address).

Normally it will read 1x register only, but the slave will continue to transmit data of sequential register addresses until the master terminates the communication.



Figure 15: I²C - MEM_READ (addressed read)

Important! A repeated START is required to perform an “addressed read”. Without repeated START, the command will be seen as a “direct read”.

As soon as incremental addressing leaves the address space, the slave will respond with all 0x00.

NOTES:

- Incremental readout – return 0x00 when address out of valid space
- **NAK is needed from master** to allow going to STOP

6.4.1.2. MEM_WRITE (addressed write) Command

MEM_WRITE: the start address will be specified followed by the data to be stored at addresses starting from the given start address and incremented until an I²C stop (P) is detected.
Incremental write starting at a given address (Register Start Address).
Normally you write 1x register only, but optionally the master can continue to transmit data of sequential register addresses to reduce the communication time when a lot of registers should be written.

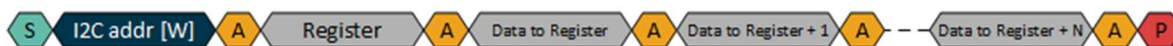
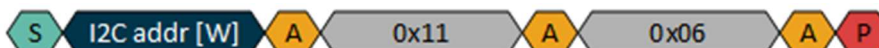

Figure 16: I²C - MEM_WRITE (addressed write) Command

The slave is sending AK/NAK based on the fact whether it was able to write data
The slave will automatically increment the address of the read out byte, independent if it gave an AK or a NAK to the master. It is up to the master to re-write the byte afterwards.
When the device is busy with the write operation, new write commands will be ignored. A read operation will return invalid data.

6.4.1.3. ADDRESSED_RESET: Addressed reset



The addressed reset command brings the device back into a state like it was after power-on.
The I²C Slave Address is used, which means that only the addressed devices on the I²C bus will be reset.

6.5. Memory Items Description

6.5.1. Memory Structure

The MLX90397 has registers (ports) of 16 addresses. Each address consists of 8 bits data. Data is transferred to or received from the external CPU via the I²C interface.

Address	Name	Description	R/W	7	6	5	4	3	2	1	0
0x00	STAT1	Status Register 1	R	-	-	-	-	RT	-	-	DRDY
0x01	X[7:0]	X-axis Measurement Magnetic Data [7:0]	R	-	-	-	-	-	-	-	-
0x02	X[15:8]	X-axis Measurement Magnetic Data [15:8]	R	-	-	-	-	-	-	-	-
0x03	Y[7:0]	Y-axis Measurement Magnetic Data [7:0]	R	-	-	-	-	-	-	-	-
0x04	Y[15:8]	Y-axis Measurement Magnetic Data [15:8]	R	-	-	-	-	-	-	-	-
0x05	Z[7:0]	Z-axis Measurement Magnetic Data [7:0]	R	-	-	-	-	-	-	-	-
0x06	Z[15:8]	Z-axis Measurement Magnetic Data [15:8]	R	-	-	-	-	-	-	-	-
0x07	STAT2	Status Register 2	R	-	-	-	-	DOR	HOVF_Z	HOVF_Y	HOVF_X
0x08	T[7:0]	Temperature Measurement Data Lower 8-bit	R	-	-	-	-	-	-	-	-
0x09	T[15:8]	Temperature Measurement Data Higher 8-bit	R	-	-	-	-	-	-	-	-
0x0A	CID	Company ID [7:0]	R	-	-	-	-	-	-	-	-
0x0B	DID	Device ID [7:0]	R	-	-	-	-	-	-	-	-
0x0C		Not used		-	-	-	-	-	-	-	-
0x0D		Not used		-	-	-	-	-	-	-	-
0x0E	CTRL	Control Register (Application Mode)	R/W	-	Z_EN	Y_EN	X_EN	MODE[3:0]			
0x0F	CUST_CTRL2	Second Control Register (Application Mode)	R/W	-	-	-	-	RANGE_SEL[2:0]			
0x10		Not used		-	-	-	-	-	-	-	-
0x11	RST	Reset = 0x06	R/W	-	-	-	-	-	-	-	-
0x12		Not used		-	-	-	-	-	-	-	-
0x13		Not used		-	-	-	-	-	-	-	-
0x14	OSR_DIG_FILT	OSR_DIG_FILT[7:0]	R/W	OSR_HALL	OSR_TEMP	DIG_FILT_HALL_XY[2:0]			DIG_FILT_TEMP[2:0]		
0x15	T_EN_DIG_FILT_Z	CUST_CTR	R/W	DNC=1	DNC=0	T_COMP_EN	DNC=1	-	DIG_FILT_HALL_Z[2:0]		

Table 17: Memory map

DNC=Do Not Change

The **STAT1** register is mapped on address **0x00**, since it is the default address of **MEM_DIRECT_READ** (direct read) command.

The idea is that first the user has to read the status bits **DRDY** to check if there is new data and if there is new data, to continue the command to read the registers **X**, **Y** and **Z**.

6.5.2. I/O Registers Description

6.5.2.1. Address 0x00. STAT1[7:0]

7	6	5	4	3	2	1	0
STAT1_7	STAT1_6	STAT1_5	STAT1_4	RT	STAT1_2	STAT1_1	DRDY
RW-0	RW-0	RW-0	RW-0	RW-1	RW-0	RW-0	RW-0

NOTE: R=Read access; W=Write access; value following dash (-) = value after reset

Bit 7-4	STAT1[7:4] Reserved (Not used)
Bit 3	RT The device is reset 0 – The device was not reset 1 – The device was reset and this is the first reading. Automatically set to 0 when the first reading of STAT register is done.
Bit 2-1	STAT1[2:1] Reserved (Not used)
Bit 0	DRDY Data ready DRDY bit turns to “1” when data is ready in “Single measurement” mode, or “Continuous measurement” mode. It returns to “0” when any one the measurement register (X, Y, or Z) is read 0 – Normal 1 – Data is ReaDY

6.5.2.2. Addresses 0x00-0x06. XYZ[15:0]

0x01	X[7:0] LSByte of X-axis
0x02	X[15:8] MSByte of X-axis
0x03	Y[7:0] LSByte of Y-axis
0x04	Y[15:8] MSByte of Y-axis
0x05	Z[7:0] LSByte of Z-axis
0x06	Z[15:8] MSByte of Z-axis

6.5.2.3. Address 0x07. STAT2[7:0]

7	6	5	4	3	2	1	0
STAT2_7	STAT2_6	STAT2_5	STAT2_4	DOR	HOVF_Z	HOVF_Y	HOVF_X
RW-0	RW-0	RW-0	RW-0	RW-0	RW-0	RW-0	RW-0

NOTE: R=Read access; W=Write access; value following dash (-) = value after reset

Bit 7-4	STAT2[7:4] Reserved (Not used)
Bit 3	DOR Data overrun DOR bit turns to “1” when data has been skipped in “Continuous measurement” mode. It returns to “0” when the data registers (X, Y, Z) are read 0 – Normal 1 – Data OverRun
Bit 2	HOVF_Z Z-axis magnetic sensor overflow 0 – Normal 1 – Magnetic Sensor OverFlow occurred
Bit 1	HOVF_Y Y-axis magnetic sensor overflow 0 – Normal 1 – Magnetic Sensor OverFlow occurred
Bit 0	HOVF_X X-axis magnetic sensor overflow 0 – Normal 1 – Magnetic Sensor OverFlow occurred

In "Single measurement" mode, "Continuous measurement" mode, the magnetic sensor may overflow even though the measurement data register is not saturated. In this case, measurement data is not correct and HOVF bit turns to “1”. When the measurement data register is updated, HOVF bit is updated.

6.5.2.4. Addresses 0x08-0x09. T[15:0]

0x08	T[7:0] LSByte of the temperature
0x09	T[15:8] MSByte of the temperature

6.5.2.5. Address 0x0A. CID[7:0]

0x0A	CID[7:0] Company ID
------	----------------------------

6.5.2.6. Address 0x0B. DID[7:0]

0x0B	DID[7:0] Device ID
------	---------------------------

6.5.2.7. Address 0x0E. CTRL[7:0]

7	6	5	4	3	2	1	0
CTRL_7	Z_EN	Y_EN	X_EN	MODE3	MODE2	MODE1	MODE0
RW-0	RW-0	RW-0	RW-0	RW-0	RW-0	RW-0	RW-0

NOTE: R=Read access; W=Write access; value following dash (-) = value after reset

Bit 7	CTRL[7] Reserved (Not used)
Bit 6	Z_EN Enable Z-axis magnetic measurement 0 – Disable 1 – Enable
Bit 5	Y_EN Enable Y-axis magnetic measurement 0 – Disable 1 – Enable
Bit 4	X_EN Enable X-axis magnetic measurement 0 – Disable 1 – Enable
Bit 3-0	MODE[3:0] Application mode 0 – Power-down mode 1 – Single measurement mode 2 – Continuous measurement mode 10Hz 3 – Continuous measurement mode 20Hz 4 – Continuous measurement mode 50Hz 5 – Continuous measurement mode 100Hz 6 – Continuous measurement mode 125Hz 7 – Not used 8 – Power-down mode (same as 0) 9 – Single measurement mode (same as 1) 10 – Continuous measurement mode 200Hz 11 – Continuous measurement mode 500Hz 12 – Continuous measurement mode 700Hz 13 – Continuous measurement mode 1.0kHz 14 – Continuous measurement mode 1.4kHz 15 – Power-down mode (same as 0)

6.5.2.8. Address 0x0F. CUST_CTRL2[7:0]

7	6	5	4	3	2	1	0
CUST_CTRL2_ 7	CUST_CTRL2_ 6	CUST_CTRL2_ 5	CUST_CTRL2_ 4	CUST_CTRL2_ 3	RANGE_SEL_ 2	RANGE_SEL_ 1	RANGE_SEL_ 0
RW-0	RW-0	RW-0	RW-0	RW-0	RW-0	RW-0	RW-0

Bit 7-3	CUST_CTRL2[7-3] Reserved (Not used)
Bit 2-0	RANGE_SEL[2:0] Select magnetic range 0 – X and Y axes = 25mT, Z axis = 25mT 1 – X and Y axes = 50mT, Z axis = 25mT 2 – X and Y axes = 25mT, Z axis = 50mT 3 – X and Y axes = 50mT, Z axis = 50mT 4 – X and Y axes = 25mT, Z axis = 100mT 5 – X and Y axes = 50mT, Z axis = 100mT 6 – X and Y axes = 25mT, Z axis = 200mT 7 – X and Y axes = 50mT, Z axis = 200mT

6.5.2.9. Address 0x11. RST[7:0]

0x11	RST[7:0] Addressed RESET when users sends an I2C_ADDRESSED_RESET command
------	---

6.5.2.10. Addresses 0x12-0x13. Not Used

6.5.2.11. Address 0x14. OSR_DIG_FILT[7:0]

7	6	5	4	3	2	1	0
OSR_HALL	OSR_TEMP	DIG_FILT_HALL_XY2	DIG_FILT_HALL_XY1	DIG_FILT_HALL_XY0	DIG_FILT_TEMP_MP2	DIG_FILT_TEMP_MP1	DIG_FILT_TEMP_MPO
RW-0	RW-0	RW-0	RW-0	RW-0	RW-0	RW-0	RW-0

NOTE: R=Read access; W=Write access; value following dash (-) = value after reset

Bit 7	<p>OSR_HALL Over sampling ratio setting for the magnetic measurements</p> <p>0 – OSR = 32</p> <p>1 – OSR = 64</p>
Bit 6	<p>OSR_TEMP Over sampling ratio setting for the temperature measurement</p> <p>0 – OSR = 32</p> <p>1 – OSR = 64</p>
Bit 5-3	<p>DIG_FILT_HALL_XY[2:0] DIG_FILT setting for X and Y magnetic measurements</p> <p>0 – 0.113ms @ OSR_HALL = 0; 0.220ms @ OSR_HALL = 1</p> <p>1 – 0.167ms @ OSR_HALL = 0; 0.327ms @ OSR_HALL = 1</p> <p>2 – 0.273ms @ OSR_HALL = 0; 0.540ms @ OSR_HALL = 1</p> <p>3 – 0.487ms @ OSR_HALL = 0; 0.967ms @ OSR_HALL = 1</p> <p>4 – 0.913ms @ OSR_HALL = 0; 1.820ms @ OSR_HALL = 1</p> <p>5 – 1.767ms @ OSR_HALL = 0; 3.527ms @ OSR_HALL = 1</p> <p>6 – 3.473ms @ OSR_HALL = 0; 6.940ms @ OSR_HALL = 1</p> <p>7 – 6.887ms @ OSR_HALL = 0; 13.767ms @ OSR_HALL = 1</p>
Bit 2-0	<p>DIG_FILT_TEMP[2:0] DIG_FILT setting for the temperature measurement</p> <p>0 – 0.113ms @ OSR_TEMP = 0; 0.220ms @ OSR_TEMP = 1</p> <p>1 – 0.167ms @ OSR_TEMP = 0; 0.327ms @ OSR_TEMP = 1</p> <p>2 – 0.273ms @ OSR_TEMP = 0; 0.540ms @ OSR_TEMP = 1</p> <p>3 – 0.487ms @ OSR_TEMP = 0; 0.967ms @ OSR_TEMP = 1</p> <p>4 – 0.913ms @ OSR_TEMP = 0; 1.820ms @ OSR_TEMP = 1</p> <p>5 – 1.767ms @ OSR_TEMP = 0; 3.527ms @ OSR_TEMP = 1</p> <p>6 – 3.473ms @ OSR_TEMP = 0; 6.940ms @ OSR_TEMP = 1</p> <p>7 – 6.887ms @ OSR_TEMP = 0; 13.767ms @ OSR_TEMP = 1</p>

6.5.2.12. Address 0x15. CUST_CTRL[7:0]

7	6	5	4	3	2	1	0
DNC = 1	DNC = 0	T_COMP_EN	DNC = 1	CUST_CTRL3	DIG_FILT_HALL_Z2	DIG_FILT_HALL_Z1	DIG_FILT_HALL_Z0
RW-0	RW-0	RW-0	RW-0	RW-0	RW-0	RW-0	RW-0

NOTE: R=Read access; W=Write access; value following dash (-) = value after reset

Bit 7	DNC=1 Value is preloaded from OTP with 0b1. Do not change it.
Bit 6	DNC=0 Value is preloaded from OTP with 0b0. Do not change it.
Bit 5	T_COMP_EN Enable or disabled the temperature measurement and compensation 0 – Disabled 1 – Enabled
Bit 4	DNC=1 Value is preloaded from OTP with 0b1. Do not change it.
Bit 3	CUST_CTRL3 Reserved (Not used)
Bit 2-0	DIG_FILT_HALL_Z[2:0] DIG_FILT setting for Z magnetic measurement 0 – 0.113ms @ OSR_HALL = 0; 0.220ms @ OSR_HALL = 1 1 – 0.167ms @ OSR_HALL = 0; 0.327ms @ OSR_HALL = 1 2 – 0.273ms @ OSR_HALL = 0; 0.540ms @ OSR_HALL = 1 3 – 0.487ms @ OSR_HALL = 0; 0.967ms @ OSR_HALL = 1 4 – 0.913ms @ OSR_HALL = 0; 1.820ms @ OSR_HALL = 1 5 – 1.767ms @ OSR_HALL = 0; 3.527ms @ OSR_HALL = 1 6 – 3.473ms @ OSR_HALL = 0; 6.940ms @ OSR_HALL = 1 7 – 6.887ms @ OSR_HALL = 0; 13.767ms @ OSR_HALL = 1

6.6. Flowchart

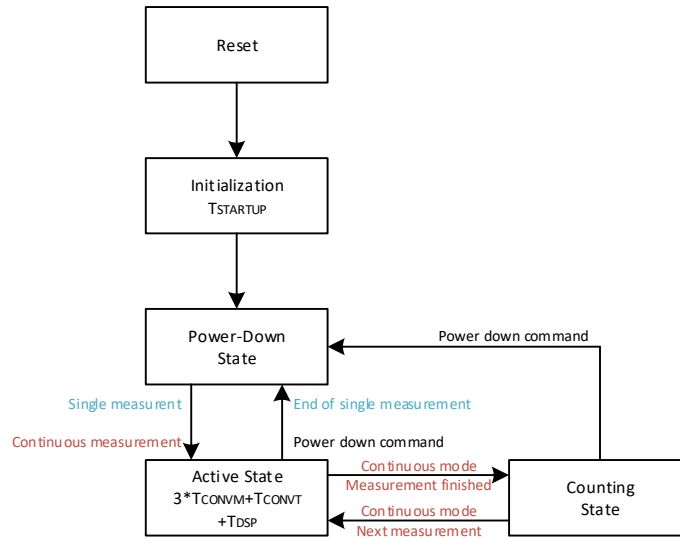

Figure 17: Sequence flowchart

6.7. Noise Performance Graphs

6.7.1. Without temperature compensation

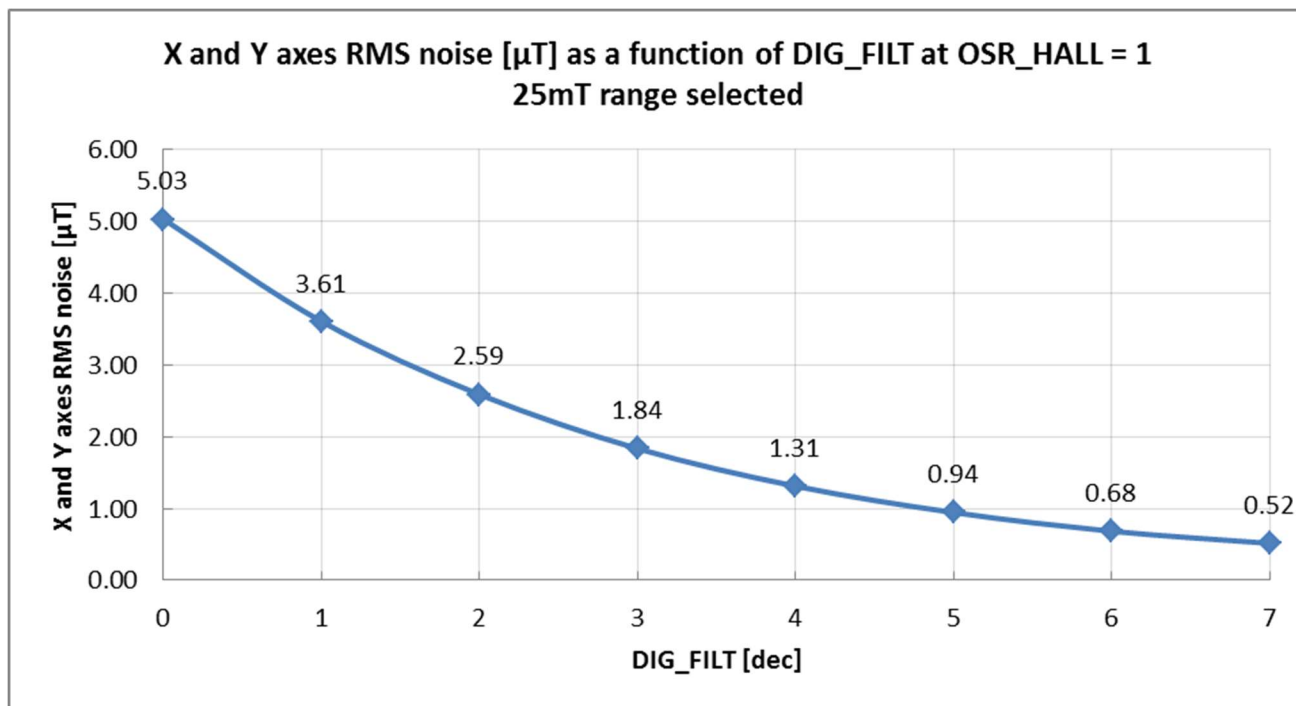

Figure 18: XY axis RMS noise (typ) without temperature compensation and 25mT range selected

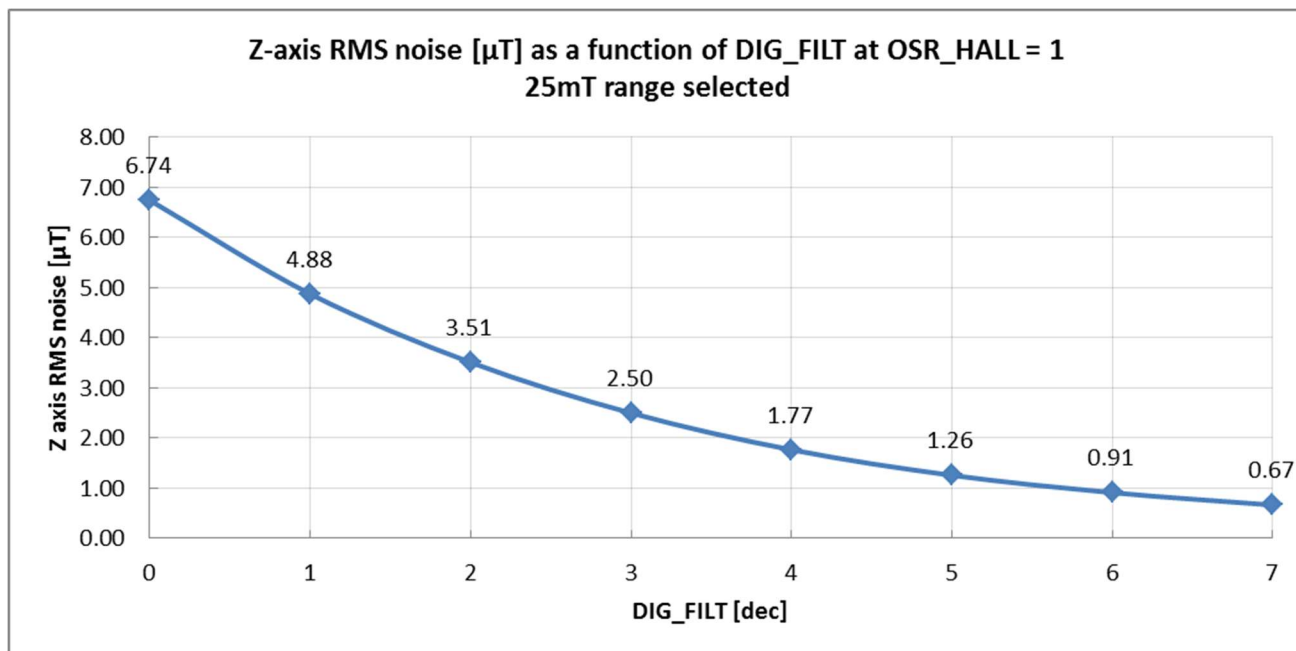

Figure 19: Z axis RMS noise (typ) without temperature compensation and 25mT range selected

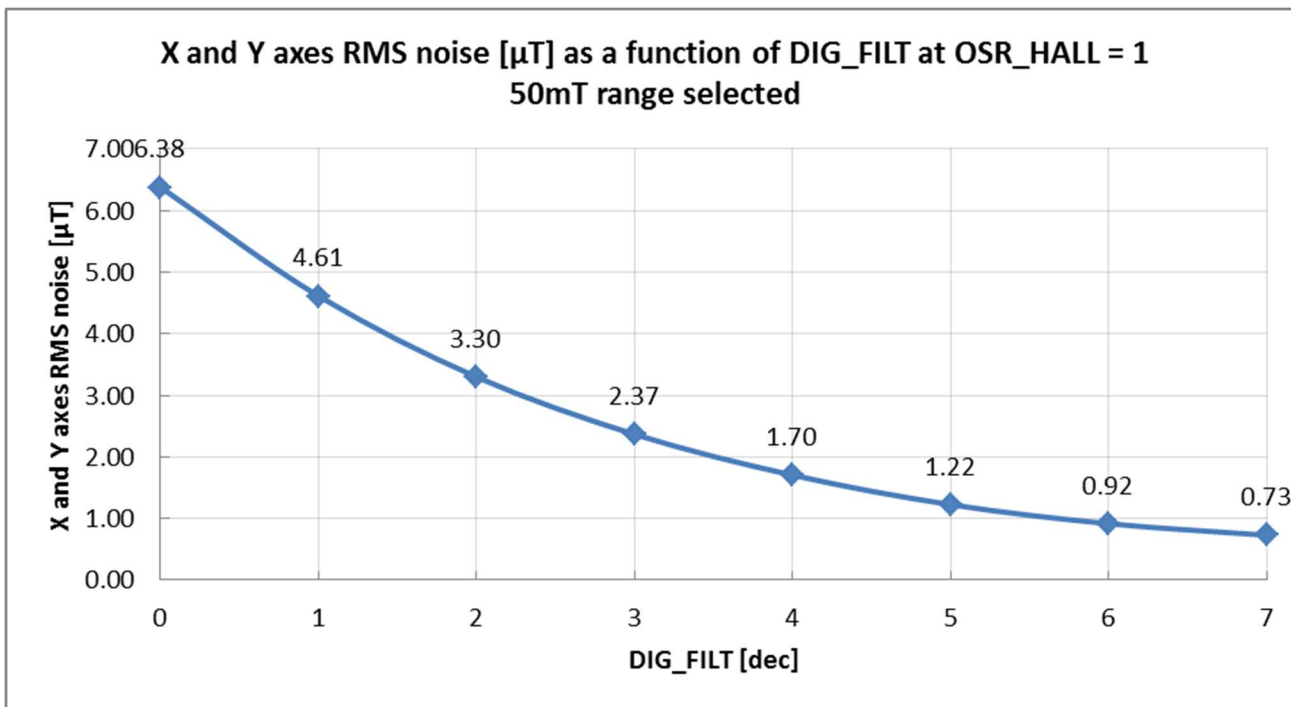

Figure 20: XY axis RMS noise (typ) without temperature compensation and 50mT range selected

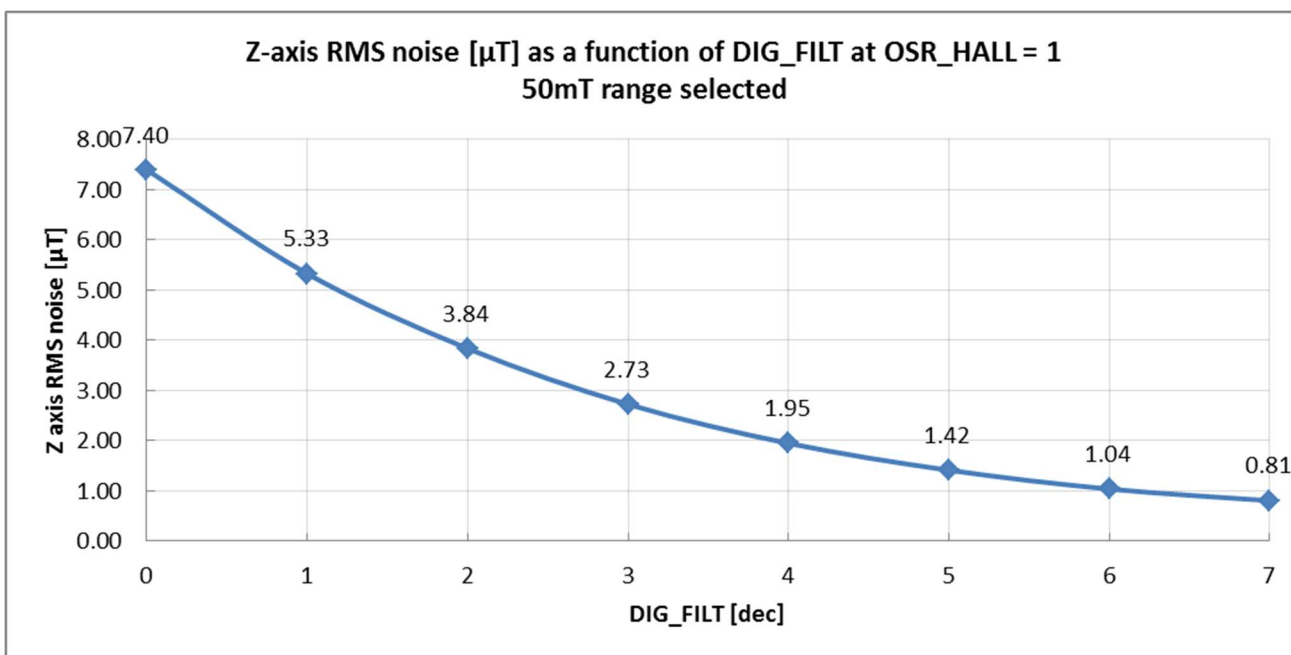

Figure 21: Z axis RMS noise (typ) without temperature compensation and 50mT range selected

6.7.2. With temperature compensation

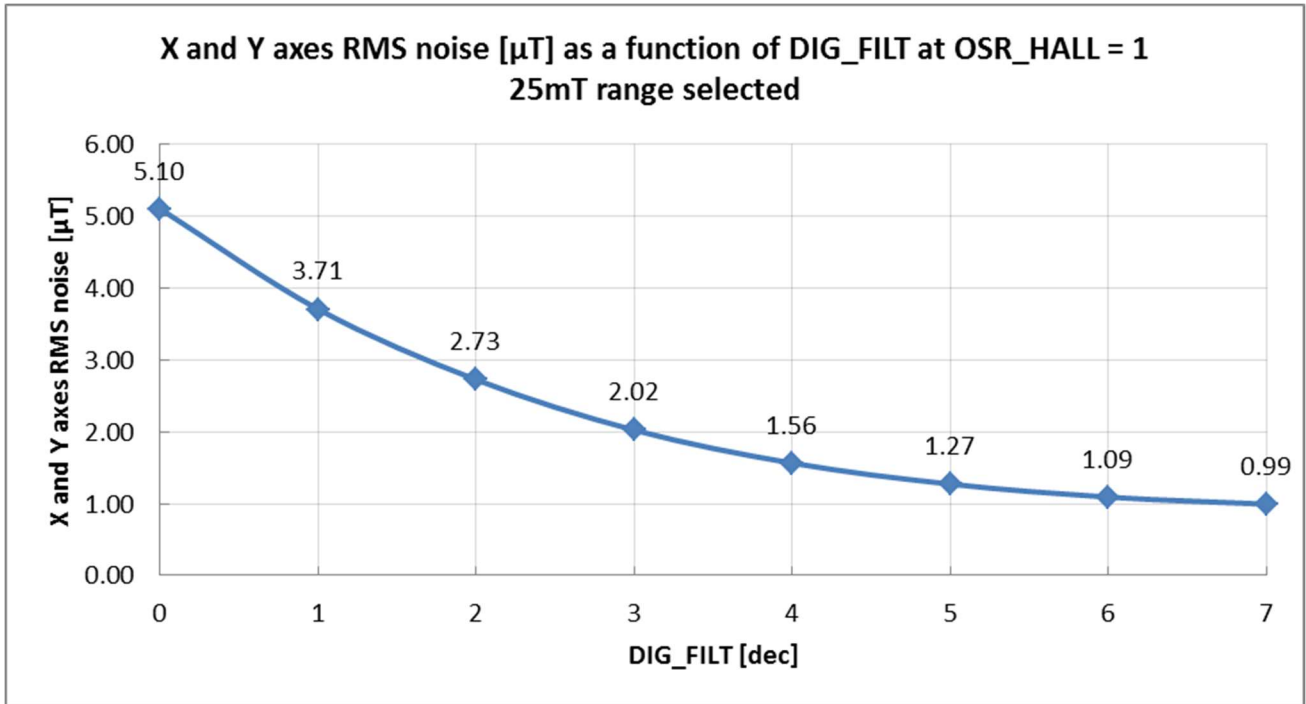

Figure 22: XY axis RMS noise (typ) with temperature compensation and 25mT range selected

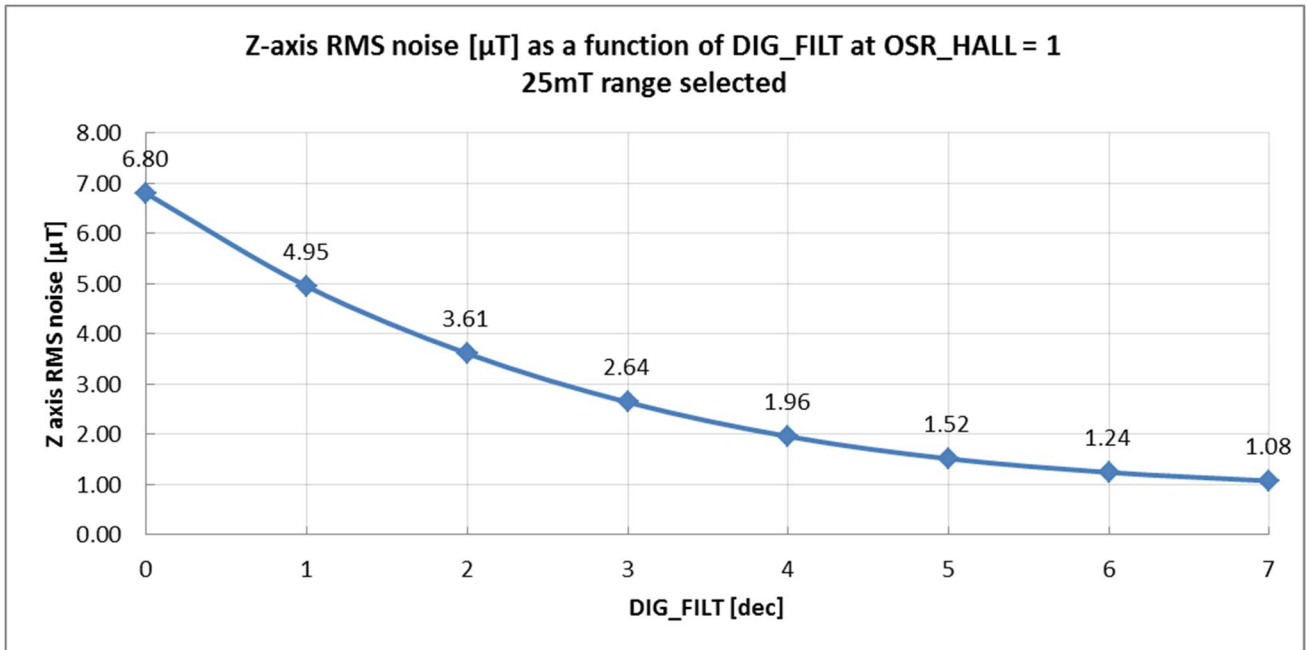

Figure 23: Z axis RMS noise (typ) with temperature compensation and 25mT range selected

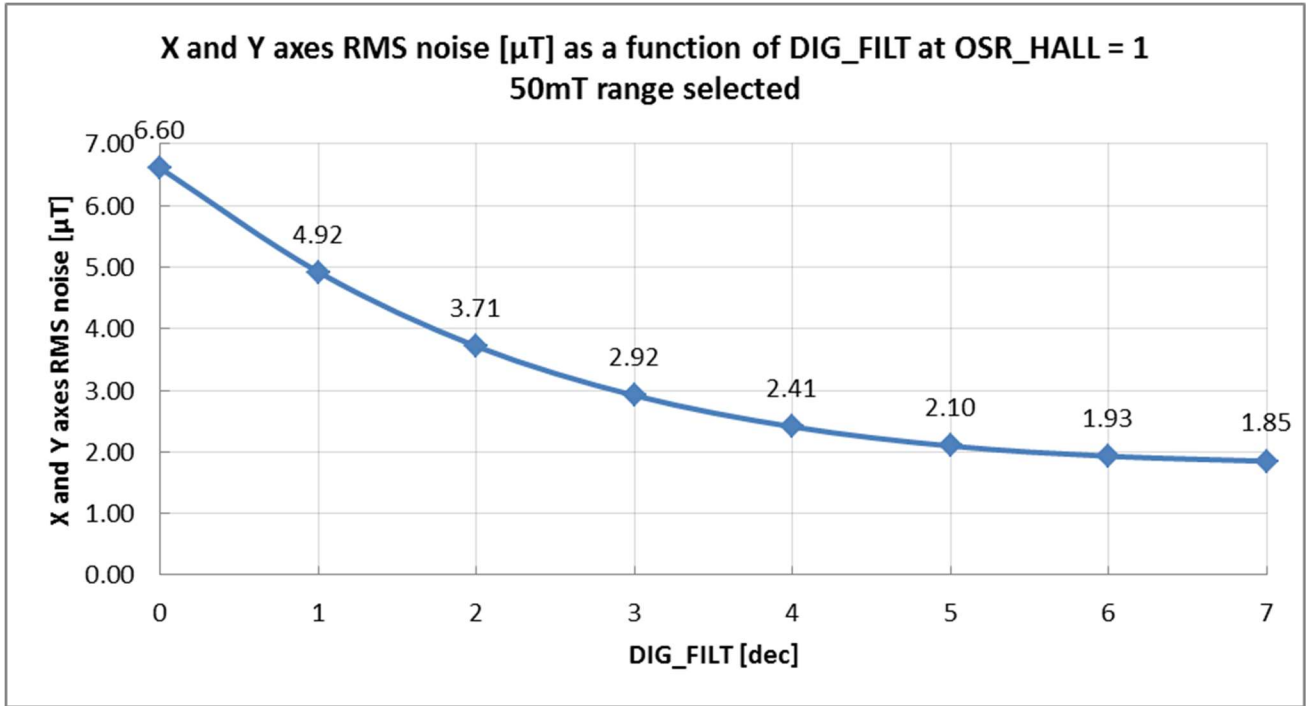

Figure 24: XY axis RMS noise (typ) with temperature compensation and 50mT range selected

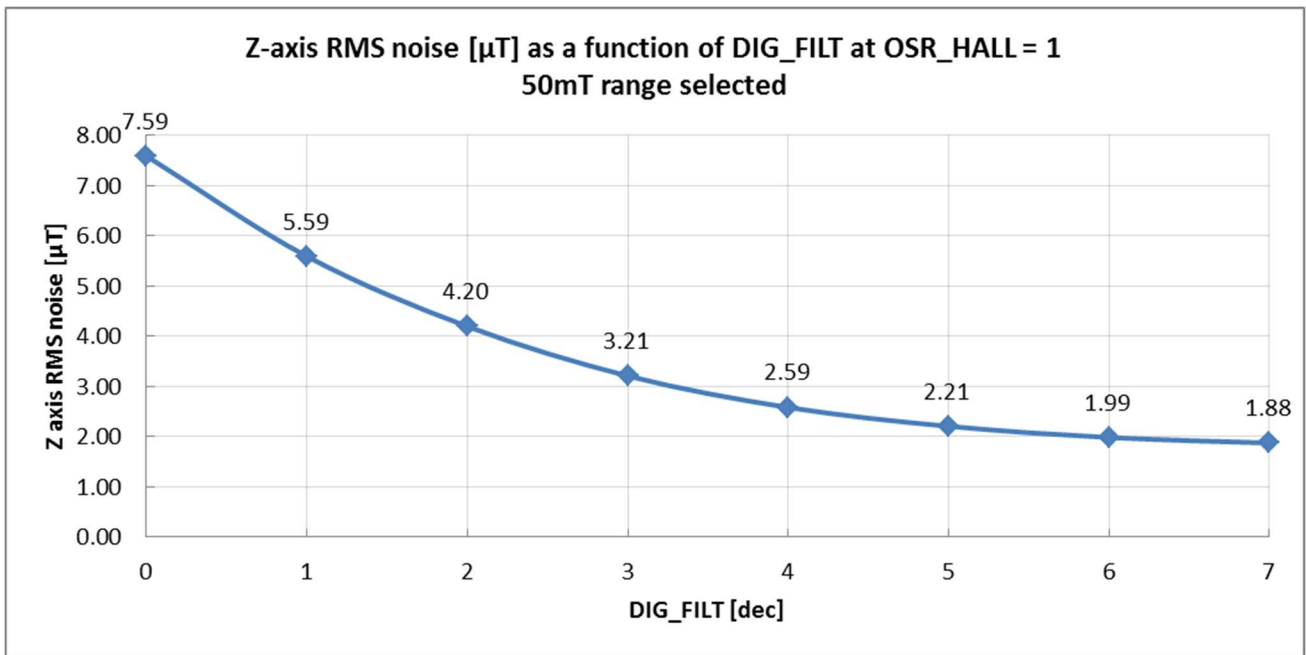

Figure 25: Z axis RMS noise (typ) with temperature compensation and 50mT range selected

6.8. Temperature Compensation

The MLX90397 has a built-in temperature compensation, which is done by a piecewise linear approximation of the temperature coefficient of the Hall plates. A reference temperature is chosen ($T_{REF}=35^{\circ}\text{C}$), where the result at any temperature higher than T_{REF} is adjusted by a gain $SENS_TC_HT$ and if the temperature is lower than T_{REF} - by $SENS_TC_LT$. These two coefficients are calibrated at Melexis and are lumped into the parameter name $SENS_TC$ in the equation below.

$$XYZ_{18_0} = XYZ_RAW_{18_0} \cdot \left[1 + \frac{SENS_TC_{11_0} \cdot (TEMP_{15_0} - TREF_{15_0})}{2^{SENS_TC_N_{3_0} + 18}} \right]$$

$SENS_TC_N$ is a scaling factor needed for the fixed-point calculations. It is determined and written at Melexis during the production test.

In case the temperature compensation is not needed, bit 5 in $T_EN_DIG_FILT_Z$ register is set to 0. This also disables the temperature measurement and the term in the square brackets of the formula above is equal to 1.

The operation is executed on the 19 bits raw magnetic data which is consequently truncated to 16 bit and loaded into the results registers.

7. Application information

Recommended application diagram

The MLX90397 package features an exposed pad. Considering the low self-heating of the component, no recommendation is given whether or not to connect this pad to ground.

MLX90397 can be reset by pulling down the RESB pin to GND with:

- An open-drain output of a microcontroller having a pull-down resistance of less than 5kΩ:

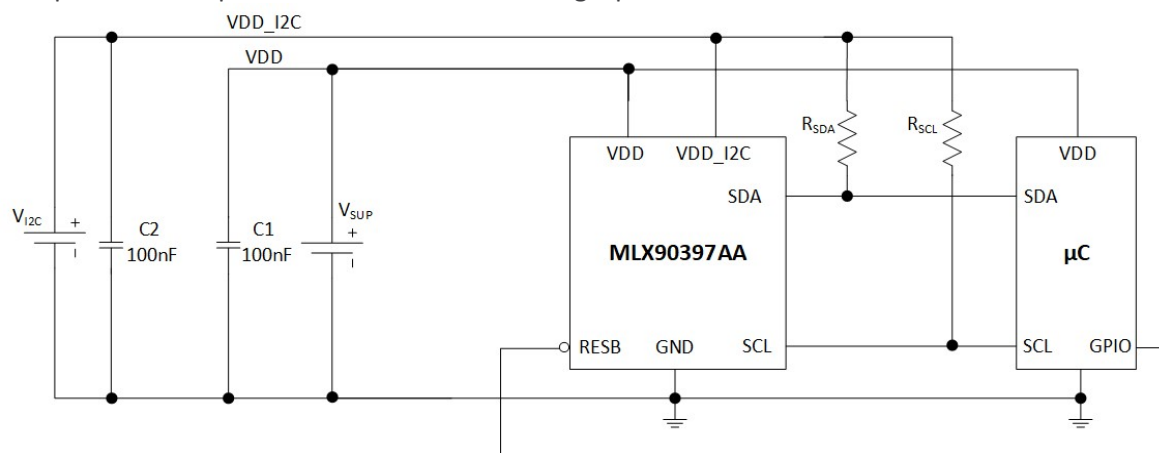

- A capacitor connected between RESB and GND pins (for start-up, without microcontroller). The capacitor value can be calculated with: $C_{RESB} \geq 500\mu A \cdot \frac{\Delta t}{\Delta V_{DD}}$, with $\frac{\Delta V_{DD}}{\Delta t}$ equal to the voltage supply ramp rate:

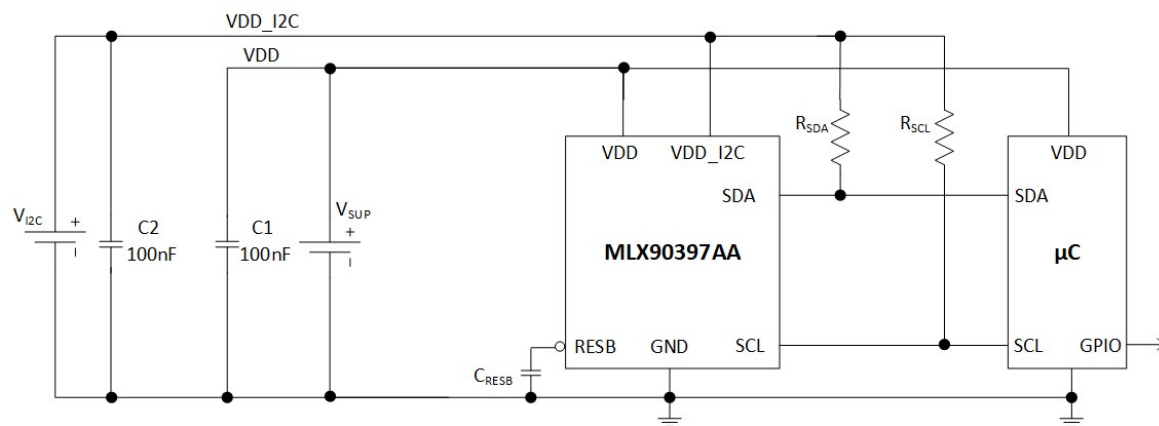

Figure 26: Recommended application diagram

Note: R_{SDA} and R_{SCL} are part of the bus specifications. Please refer to it.

8. Package and Manufacturability information

8.1. ESD precaution

Electronic semiconductor products are sensitive to Electro Static Discharge (ESD). Always observe Electro Static Discharge control procedures whenever handling semiconductor products.

8.2. Package information – UTDFN8

8.2.1. Dimensions

UTDFN 2x2.5mm

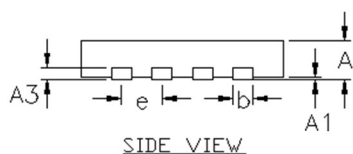
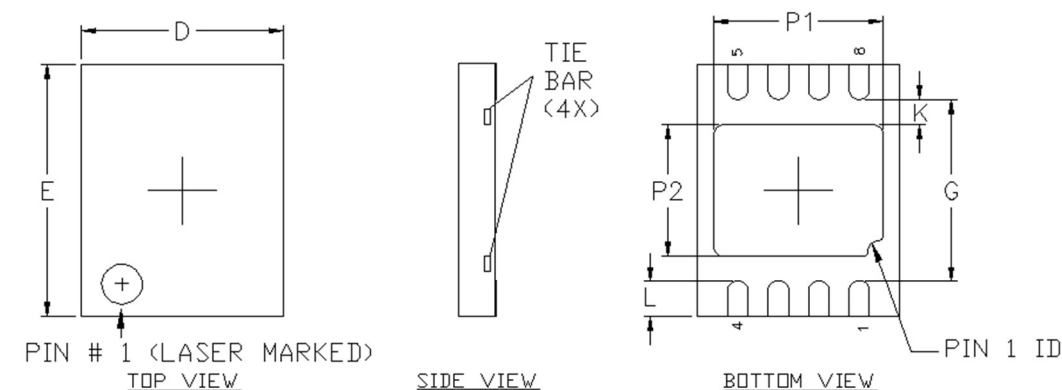

- NOTE :
1. ALL DIMENSIONS IN MILLIMETERS (mm).
 2. EXPOSED TIE BAR SHOULD BE KEPT FREE FROM SOLDER.

S Y M B O L	MINIMUM	MAXIMUM
A	0.31	0.40
A1	0.00	0.05
A3	0.12 REF	
D	1.90	2.10
E	2.40	2.60
P1	1.45	1.70
P2	1.25	1.35
G	1.75	1.85
L	0.25	0.45
K	0.20	---
b	0.16	0.24
e	0.40 BSC	

8.2.2. Sensing element placement

Magnetic sweet spot

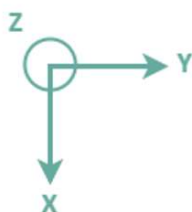
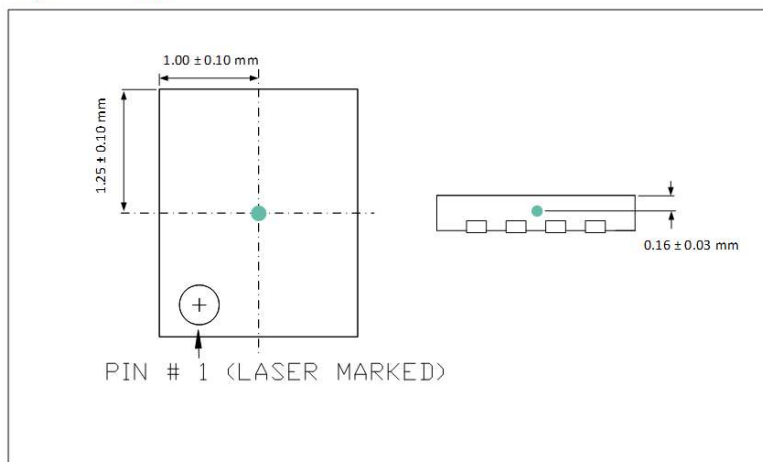
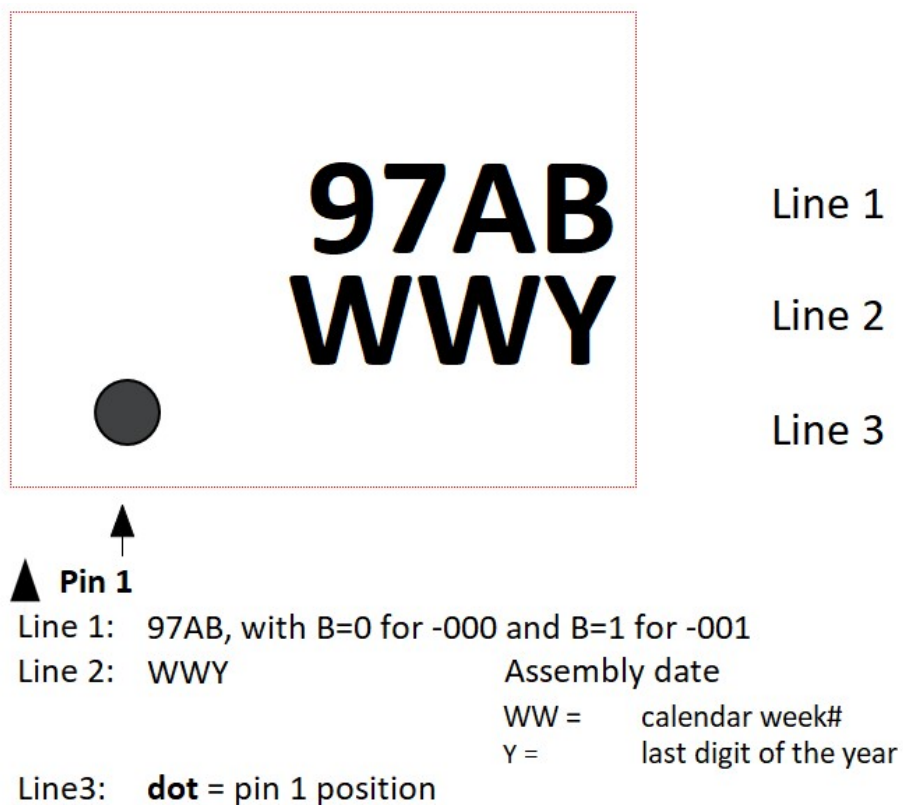

Figure 27: Field convention (Top view of the package with pin 1 at the bottom left)

8.2.3. Top Marking



8.3. Standard information on soldering processes

8.3.1. Storage and handling of plastic encapsulated ICs

Plastic encapsulated ICs shall be stored and handled according to their MSL categorization level (specified in the packing label) as per J-STD-033.

Electronic semiconductor products are sensitive to Electro Static Discharge (ESD). The component assembly shall be handled in EPA (Electrostatic Protected Area) as per ANSI S20.20

For more information refer to Melexis [Guidelines for storage and handling of plastic encapsulated ICs](#)⁽¹³⁾

8.3.2. Assembly of encapsulated ICs

For Surface Mounted Devices (SMD, as defined according to JEDEC norms), the only applicable soldering method is reflow.

For Through Hole Devices (THD), the applicable soldering methods are reflow, wave, selective wave and robot point-to-point. THD lead pre-forming (cutting and/or bending) is applicable under strict compliance with Melexis [Guidelines for lead forming of SIP Hall Sensors](#)⁽¹³⁾.

Melexis products soldering on PCB should be conducted according to the requirements of IPC/JEDEC and J-STD-001. Solder quality acceptance should follow the requirements of IPC-A-610.

For PCB-less assembly refer to the relevant application notes⁽¹³⁾ or contact Melexis.

Electrical resistance welding or laser welding can be applied to Melexis products in THD and specific PCB-less packages following the [Guidelines for welding of PCB-less devices](#)⁽¹³⁾.

Environmental protection of customer assembly with Melexis products for harsh media application, is applicable by means of coating, potting or overmolding considering restrictions listed in the relevant application notes⁽¹³⁾

For other specific process, contact Melexis via www.melexis.com/technical-inquiry

8.3.3. Environment and sustainability

Melexis is contributing to global environmental conservation by promoting non-hazardous solutions.

For more information on our environmental policy and declarations (RoHS, REACH...) visit www.melexis.com/environmental-forms-and-declarations

¹³ www.melexis.com/ic-handling-and-assembly

9. Tables

<i>Table 1: Ordering codes</i>	2
<i>Table 2: Glossary of terms</i>	5
<i>Table 3: Pin description</i>	6
<i>Table 4: Absolute Maximum Ratings</i>	7
<i>Table 5: General operating conditions</i>	8
<i>Table 6: Electrical operating conditions</i>	8
<i>Table 7: Magnetic operating conditions</i>	8
<i>Table 8: Electrical Specifications</i>	10
<i>Table 9: Magnetic Specifications</i>	13
<i>Table 10: Timing specifications</i>	14
<i>Table 11: Accuracy specifications</i>	17
<i>Table 12: Operating modes</i>	18
<i>Table 13: Example of settings satisfying the timing consideration for proper operation in continuous measurement mode</i>	22
<i>Table 14: Magnetic data format</i>	24
<i>Table 15: XY and Z magnetic range selection</i>	25
<i>Table 16: 8-bits Addressing register</i>	25
<i>Table 17: Memory map</i>	29
<i>Table 18: Revisions</i>	48

10. Figures

Figure 1: Block diagram	6
Figure 2: Average Consumption vs Filtering – Continuous measurement mode - Temperature compensation on	11
Figure 3: Average Consumption vs Filtering – Continuous measurement at all possible speeds – Temp compensation off	11
Figure 4: Average consumption vs Filtering – Continuous measurements at 10Hz – Temperature compensation off	12
Figure 5: Conversion time vs. digital filtering (DIG_FILT) at typical Fclk = 2.4MHz	15
Figure 6: DSP time vs. number of enabled magnetic axes at typical Fclk = 2.4MHz.	16
Figure 7: Single measurement mode when data is read out of measurement period	19
Figure 8: Single measurement mode when data read started during measurement period	19
Figure 9: Continuous measurement mode	20
Figure 10: Normal read sequence	21
Figure 11: Data read start during measurement	21
Figure 12: Data Skip: When data is not read	23
Figure 13: Data Skip: When data read has not been finished before the next measurement end	23
Figure 14: I ² C - MEM_DIRECT_READ (direct read) Command	27
Figure 15: I ² C - MEM_READ (addressed read)	27
Figure 16: I ² C - MEM_WRITE (addressed write) Command	28
Figure 17: Sequence flowchart	36
Figure 18: XY axis RMS noise (typ) without temperature compensation and 25mT range selected	37
Figure 19: Z axis RMS noise (typ) without temperature compensation and 25mT range selected	37
Figure 20: XY axis RMS noise (typ) without temperature compensation and 50mT range selected	38
Figure 21: Z axis RMS noise (typ) without temperature compensation and 50mT range selected	38
Figure 22: XY axis RMS noise (typ) with temperature compensation and 25mT range selected	39
Figure 23: Z axis RMS noise (typ) with temperature compensation and 25mT range selected	39
Figure 24: XY axis RMS noise (typ) with temperature compensation and 50mT range selected	40
Figure 25: Z axis RMS noise (typ) with temperature compensation and 50mT range selected	40
Figure 26: Recommended application diagram	42
Figure 27: Field convention (Top view of the package with pin 1 at the bottom left)	44

11. Revision History

Revision	Date	Change history
001	14-March-2022	First datasheet
002	23-Dec-2022	Cosmetic changes Note on exposed pad Idle mode -> Power-Down mode Update Application diagram (removal of capacitor), added description for RESB Order code added -001, including package marking update Remove line regarding RESB resistor from table electrical specifications (moved to description for RESB) Correction formula T_CONV

Table 18: Revisions

12. Disclaimer

The content of this document is believed to be correct and accurate. However, the content of this document is furnished "as is" for informational use only and no representation, nor warranty is provided by Melexis about its accuracy, nor about the results of its implementation. Melexis assumes no responsibility or liability for any errors or inaccuracies that may appear in this document. Customer will follow the practices contained in this document under its sole responsibility. This documentation is in fact provided without warranty, term, or condition of any kind, either implied or expressed, including but not limited to warranties of merchantability, satisfactory quality, non-infringement, and fitness for purpose. Melexis, its employees and agents and its affiliates' and their employees and agents will not be responsible for any loss, however arising, from the use of, or reliance on this document. Notwithstanding the foregoing, contractual obligations expressly undertaken in writing by Melexis prevail over this disclaimer.

This document is subject to change without notice, and should not be construed as a commitment by Melexis. Therefore, before placing orders or prior to designing the product into a system, users or any third party should obtain the latest version of the relevant information.

Users or any third party must determine the suitability of the product described in this document for its application, including the level of reliability required and determine whether it is fit for a particular purpose.

This document as well as the product here described may be subject to export control regulations. Be aware that export might require a prior authorization from competent authorities. The product is not designed, authorized or warranted to be suitable in applications requiring extended temperature range and/or unusual environmental requirements. High reliability applications, such as medical life-support or life-sustaining equipment or avionics application are specifically excluded by Melexis. The product may not be used for the following applications subject to export control regulations: the development, production, processing, operation, maintenance, storage, recognition or proliferation of:

- 1. chemical, biological or nuclear weapons, or for the development, production, maintenance or storage of missiles for such weapons;*
- 2. civil firearms, including spare parts or ammunition for such arms;*
- 3. defense related products, or other material for military use or for law enforcement;*
- 4. any applications that, alone or in combination with other goods, substances or organisms could cause serious harm to persons or goods and that can be used as a means of violence in an armed conflict or any similar violent situation.*

No license nor any other right or interest is granted to any of Melexis' or third party's intellectual property rights.

If this document is marked "restricted" or with similar words, or if in any case the content of this document is to be reasonably understood as being confidential, the recipient of this document shall not communicate, nor disclose to any third party, any part of the document without Melexis' express written consent. The recipient shall take all necessary measures to apply and preserve the confidential character of the document. In particular, the recipient shall (i) hold document in confidence with at least the same degree of care by which it maintains the confidentiality of its own proprietary and confidential information, but no less than reasonable care; (ii) restrict the disclosure of the document solely to its employees for the purpose for which this document was received, on a strictly need to know basis and providing that such persons to whom the document is disclosed are bound by confidentiality terms substantially similar to those in this disclaimer; (iii) use the document only in connection with the purpose for which this document was received, and reproduce document only to the extent necessary for such purposes; (iv) not use the document for commercial purposes or to the detriment of Melexis or its customers. The confidentiality obligations set forth in this disclaimer will have indefinite duration and in any case they will be effective for no less than 10 years from the receipt of this document.

This disclaimer will be governed by and construed in accordance with Belgian law and any disputes relating to this disclaimer will be subject to the exclusive jurisdiction of the courts of Brussels, Belgium.

The invalidity or ineffectiveness of any of the provisions of this disclaimer does not affect the validity or effectiveness of the other provisions.

The previous versions of this document are repealed.

Melexis © - No part of this document may be reproduced without the prior written consent of Melexis. (2022)

IATF 16949 and ISO 14001 Certified