



LCD121-070CTL1ARNTR2.0

7" WUXGA 360 Zone Wide Gamut Full Array Local Dimming

Table of Contents

Revision History	4
Document Revision	4
Hardware Revision	4
General Specifications	5
Absolute Max Ratings.....	5
Block Diagram	6
Connector Summary	7
Connector group A	7
Pin Out – Power	7
Absolute Max Ratings – Power	8
Electrical Characteristics – Power	8
Connector B.....	9
Pin Out – FALD	9
Absolute Max Ratings – FALD	10
Electrical Characteristics – FALD	10
Connector group C	11
Pin Out – LCD / PCAP	11
Absolute Max Ratings - LCD	13
Absolute Max Ratings - PCAP	13
Electrical Characteristics - LCD	13
Electrical Characteristics - PCAP	14

FALD Control Timing.....	15
Start transmission condition:.....	15
Bit order	15
Scan Direction reference.....	15
Temperature sensing	16
Temperature sensor location	16
Optical Characteristics.....	17
HDR Characteristics	17
Colorimetry Characteristics.....	17
Packaging.....	20
Quality & Inspection Criteria	21
Terminologies:	21
Inspection Conditions	25
Acceptance Criteria Table:.....	26
Appendix 1 - Drawing	28

Revision History

Document Revision

Date	Version #	Description
1/12/22	R1.0	1 st doc release of HW2.0

Hardware Revision

Date	Version #	Description
Dec 21	R2.0	Production

General Specifications

Item	Specification	Unit
Outline Dimensions	162.92 x 104.00 x 9.44+component	mm
Display Size	7.02 Diagonal	inches
Active Area	151.20 X 94.50	mm
Pixel Pitch	0.07875 X 0.07875	mm
Number of Dots	1200 X 1920	-
Backlight Type	360 zone full array local dimming	-
Touch Panel	10 Finger Capacitive In-Cell Touch	-
Luminance	1800 - uncalibrated	cd/m ²
Interface	MIPI	-
Color Gamut Ratio DCI-P3	100	%
LCD Type	ADS 10 bit (8bit + 2bit FRC)	-

Absolute Max Ratings

Item	Symbol	Value	Unit
Operating Temperature	Topr	-20 ~ 70	°C
Storage Temperature	Tstg	-30 ~ 80	°C

Block Diagram

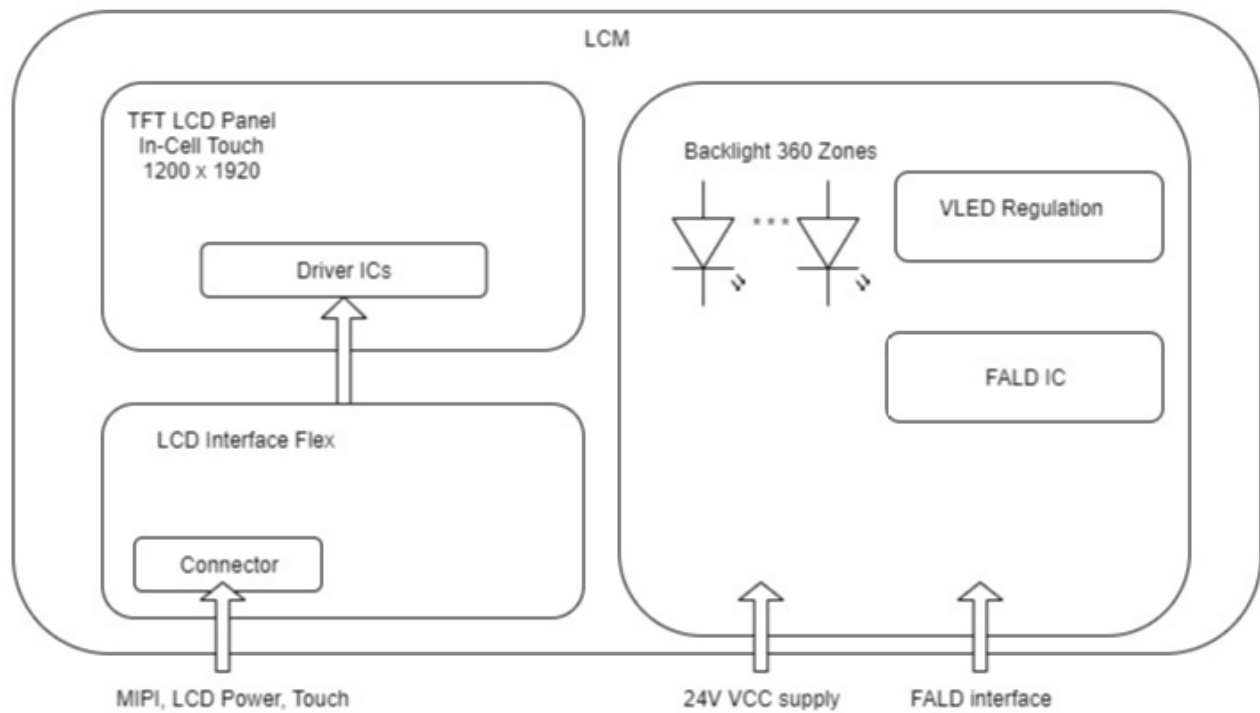

Connector Summary

There are 3 connectors of importance on this LCM and they are noted on the drawing by designators, "A", "B", "C". Connectors group "A" interface to a DC/DC buck converter with allowable input range of 12 to 40V. This design has been optimized for 24V input. Group "A" powers the LED anodes and will be bucked down to approximately 3.6V. Group A is responsible for the other system voltage generation; there is also a logic supply bank consisting of 5V, 3.3V and 1.8V powered from the same source. Connector B is the FALD interface connector. Connector group "C" is the FOG aka MIPI and Touch interface connector.

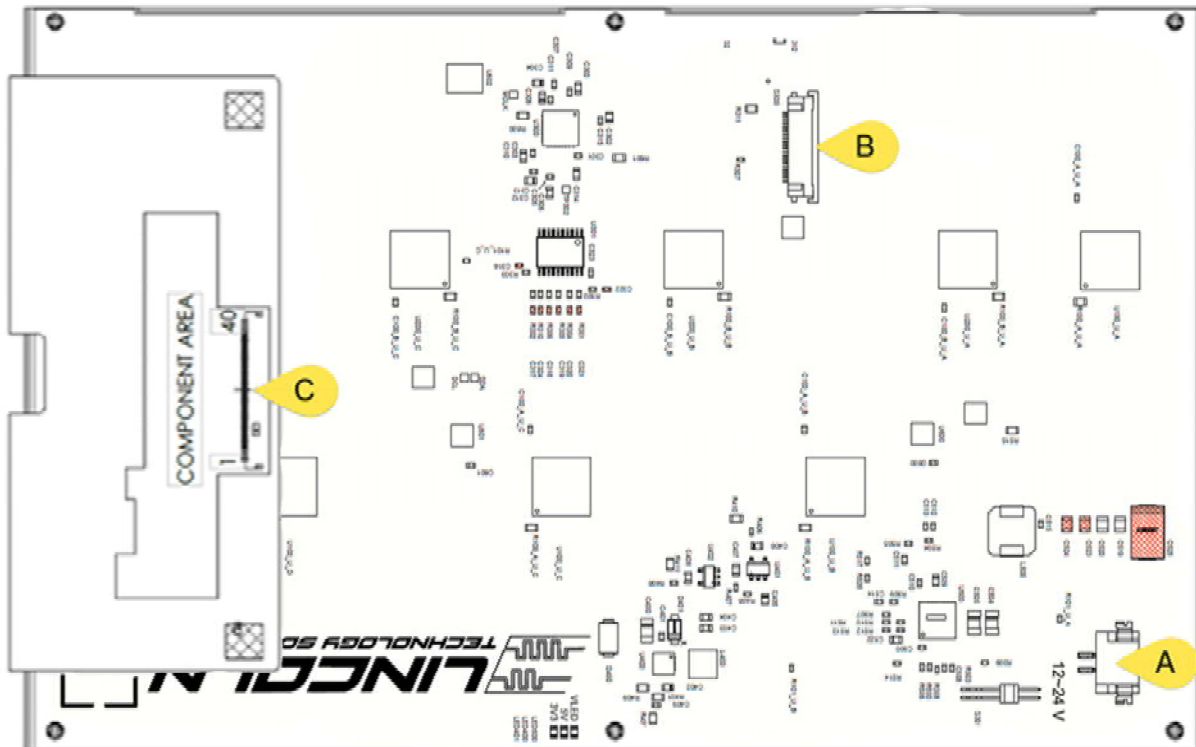

Connector group A

Pin Out – Power

The power connector is Hirose DF3EA-2P-2H and it is expecting the incoming wiring harness sized to 22AWG. This is the heaviest gauge wire that can be crimped into the connector and allows for max current of 3A per contact. It will be possible to overdrive the LED array through control over the FALD interface. Care should be taken to not exceed the maximum amperage or board temperature. Total power is TBD Watts for 1500NITS full screen.

Number	Pin Name	I/O	Description
1	VCC_24V	Power	Power input
2	GND	Power	Ground

Absolute Max Ratings – Power

Item	Symbol	Value	Unit
Supply Voltage	VCC_24V	12 ~ 40	V
Supply Current (22AWG)	VCC_24V _I	3	A
Input ripple	V _{RIP}	TBD	V

Electrical Characteristics – Power

Note, these current levels represent a typical LED refresh rate with all LEDs configured at max power of 15mA per LED.

Item	Symbol	Min	Typ	Max	Unit	Test Condition
Supply Voltage	VCC_24V	-	24	-	V	
Supply Current Connector A	I-A	-	0.275	-	mA	1800 cd/m ² 10 % Center patch - uncalibrated
Supply Current Connector A	I-A	-	1.06	-	A	2200 cd/m ² 360 Full on - uncalibrated

Connector B

Pin Out – FALD

A 20 pin Amphenol SFV20R-2STE1HLF at 0.5mm pitch with top contacts receives the FALD signaling from the host. The power rail on pin 1 is only to be used as a reference level or to power minimal consuming devices such as a level shifter on the host PCB.

Number	Pin Name	Reference V	I/O	Description
1	VCC_3V3	N/A	O	Power output
2	GND	N/A	P	Ground
3	TDI	3.3V	I	JTAG – Program interface
4	TCK	3.3V	I	JTAG – Program interface
5	TMS	3.3V	I	JTAG – Program interface
6	TDO	3.3V	O	JTAG – Program interface
7	RESETN	3.3V	I	FALD Controller reset – externally PU on FALD PCB
8	GND	N/A	P	Ground
9	SPARE_IO_LB_1V8	1.8V	I/O	Future use
10	LED_DATA_IN_1V8	1.8V	I	FALD control
11	LED_CLK_IN_1V8	1.8V	I	FALD control
12	VCC_EN	1.8V	I	Enables VLED and IC buck converter output
13	GND	N/A	P	Ground
14	DNU	N/A	-	Reserved for customer use – not connected on FALD PCB
15	DNU	N/A	-	Reserved for customer use – not connected on FALD PCB
16	DNU	N/A	-	Reserved for customer use – not connected on FALD PCB
17	TEMP_CLK_OUT_1V8	1.8V	O	FALD communications
18	TEMP_DATA_OUT_1V8	1.8V	O	FALD communications

19	DNU	N/A	-	Reserved for customer use – not connector on FALD PCB
20	GND	N/A	P	Ground

Absolute Max Ratings – FALD

Item	Symbol	Value	Unit
Max Load	VCC_3V3_FPGA	0.1	A
Logic Supply Voltage JTAG	VIN _{JTAG}	0 to 3.75	V
Logic Supply Voltage I/O	VIN _{I/O}	0 to 1.89	V

Electrical Characteristics – FALD

Item	Symbol	Min	Typ	Max	Unit	Test Condition
Operating Voltage 3V3	VCC_3V3_IO	3.135	3.3	3.6	V	-
Operating Voltage 1V8	VCC_1V8_IO	1.71	1.8	1.89	V	-
Input Voltage 3V3	V _{IH3V3}	2.0	-	3.6	V	-
	V _{IL3V3}	GND	-	0.8	V	-
Input Voltage 1V8	V _{IH1V8}	1.17	-	3.6	V	-
	V _{IL1V8}	GND	-	0.63	V	-
Output Voltage 3V3	V _{OL MAX 3V3}	-	-	0.4	V	-
	V _{OH MIN 1V8}	3.4	-	-	V	-
Output Voltage 1V8	V _{OL MAX 1V8}	-	-	0.4	V	-
	V _{OH MIN 1V8}	1.4	-	-	V	-

Connector group C

The interface connector is a 40 pin Zif with 0.5mm pitch. It accepts an FFC of 0.3mm thickness and gold-plated contacts. An example of the part mounted on the LCD flex is, Hirose FH28-40S-0.5SH(05)

Pin Out – LCD / PCAP

Number	Pin Name	I/O	Description
1	NC	-	No connection – Must not connect
2	IOVCC	P	Power supply for system (1.8V)
3	IOVCC	P	Power supply for system (1.8V)
4	GND	P	Ground
5	LCD_RSTN	I	LCD reset signal, Active Low
6	NC	-	No connection
7	GND	P	Ground
8	MIPI_0N	I	MIPI Negative data inputs
9	MIPI_0P	I	MIPI Positive data inputs
10	GND	P	Power ground
11	MIPI_1N	I	MIPI Negative data inputs
12	MIPI_1P	I	MIPI Positive data inputs
13	GND	P	Power ground
14	MIPI_CKN	I	MIPI Negative clock inputs
15	MIPI_CKP	I	MIPI Positive clock inputs
16	GND	P	Power ground
17	MIPI_2N	I	MIPI Negative data inputs
18	MIPI_2P	I	MIPI Positive data inputs

19	GND	P	Power ground
20	MIPI_3N	I	MIPI Negative data inputs
21	MIPI_3P	I	MIPI Positive data inputs
22	GND	P	Power ground
23	TP_SCL	I	TP I2C Clock 1.8V
24	TP_SDA	I/O	TP I2C Data 1.8V
25	GND	P	Power ground
26	TE	O	Tear output
27	PWMO	O	PWM control signal for LED driver (CABC)
28	TP_INT	O	Touch Interrupt 1.8V
29	TP_RST	I	TP reset signal 1.8V
30	GND	P	Power ground
31	NC	-	No connection
32	NC	-	No connection
33	NC	-	No connection
34	VSN	P	Analog supply negative voltage (-5~-6V)
35	VSN	P	Analog supply negative voltage (-5~-6V)
36	NC	-	No connection
37	VSP	P	Analog supply positive voltage (5~6V)
38	VSP	P	Analog supply positive voltage (5~6V)
39	NC	-	No connection
40	NC	-	No connection

Absolute Max Ratings - LCD

Item	Symbol	Value	Unit
Power Supply Voltage for Logic	VDD_IO	-0.3 ~ 4.5	V
Power for Analog Negative	VSN	0 ~ -6.6	V
Power for Analog Positive	VSP	0 ~ +6.6	V
Operating Temperature	Topr	-20 ~ 70	°C
Storage Temperature	Tstg	-30 ~ 80	°C

Absolute Max Ratings - PCAP

Item	Symbol	Value	Unit
Power Supply Voltage for Logic	VDD	-0.3 ~ 3.47	V
Signal IO	VDD_IO	-0.3 ~ 3.47	V

Electrical Characteristics - LCD

Item	Symbol	Min	Typ	Max	Unit	Test Condition
Operating Voltage	VDD_IO	1.65	1.8	3.6	V	-
Voltage for Analog Negative	VSN	-6.5	-5.5	-4.5	V	-
Voltage for Analog Positive	VSP	4.5	5.5	6.5	V	-
Supply Current	IDD(IOVCC)	-	-	50	mA	Ta = 25 °C
Supply Current	IDD(VSN)	-	-	75	mA	Ta = 25 °C
Supply Current	IDD(VSP)	-	-	75	mA	Ta = 25 °C
Input Voltage	Vih	0.7IOVCC	-	IOVCC	V	-
	Vil	0	-	0.3IOVCC	V	-

Item	Symbol	Min	Typ	Max	Unit	Test Condition
Input Leakage Current	I _{iL}	-1.0	-	1.0	μA	V _{in} = VDD_IO

Electrical Characteristics - PCAP

Item	Symbol	Min	Typ	Max	Unit	Test Condition
Operating Voltage	VDD	1.65	-	3.3	V	-
Operating Voltage IO	VDD_IO	1.8	-	3.3	V	
Supply Current	IDD(VCC)	-	8	14.5	mA	T _a = 25 °C
Input Voltage	V _{ih}	0.7VDD_IO	-	VDD_IO	V	-
	V _{il}	-0.3	-	0.3VCC_IO	V	-

FALD Control Timing

Start transmission condition:

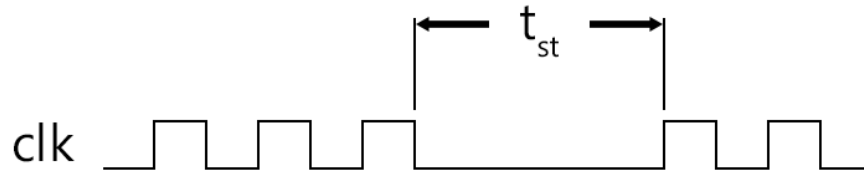

Item	Symbol	Min	Typ	Max	Unit	Test Condition
Start Transmission time	t_{st}	10	-	-	μs	-

The data clock (CLK_MB_1V8) must be static for this period to begin a data transmission

Bit order

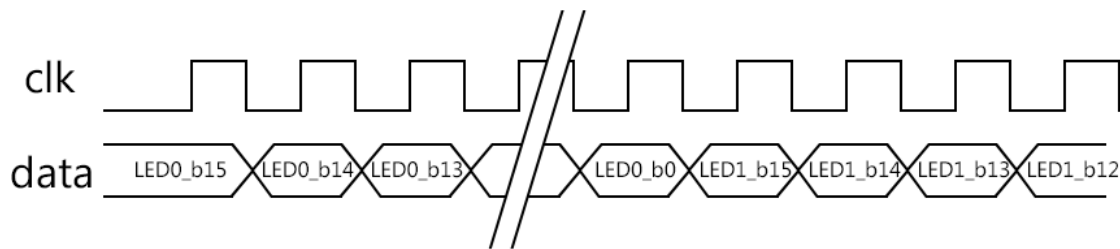

Data is to be transmitted on the rising edge of CLK MSB first starting at LED0; see scan direction reference below. Data must be transmitted for all LEDs for the panel to update brightness. To reject data prior to completing transmission, resend the start transmission condition.

Scan Direction reference

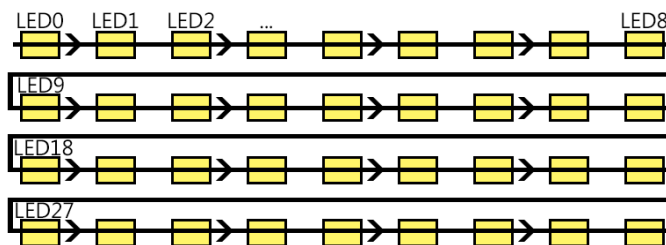

LED0 is in the upper left corner of the screen. LEDs increment left to right and continue incrementing on the left LED of the row below.

Temperature sensing

On board temperature sensors are included to monitor different regions of the PCB. 2 of LM75B are placed on the back side of the LCM. The FALD controller routinely gathers sensor data and will report back over the DATA_RETURN bus. One sensor's data will be reported over this bus every 500ms alternating between sensors 1 and 2. The full range of data is -55°C through +127°C at 0.125°C increments. See LM75B for bit definitions.

Item	Symbol	Min	Typ	Max	Unit	Test Condition
CLK_RETURN frequency	f_{clk}	-	78	-	kHz	simulation
Byte Time Delay	t_{dly}	-	58.89	-	μ s	simulation

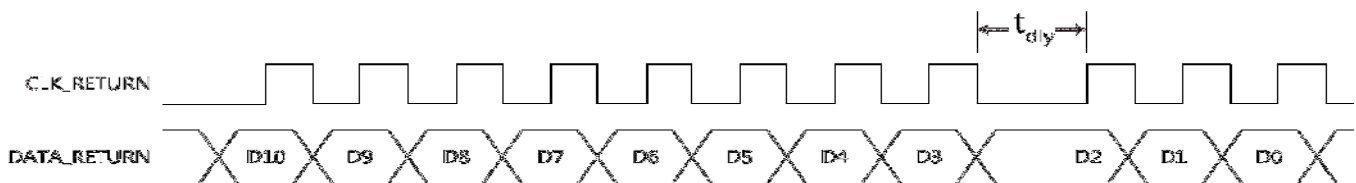

Temperature sensor location

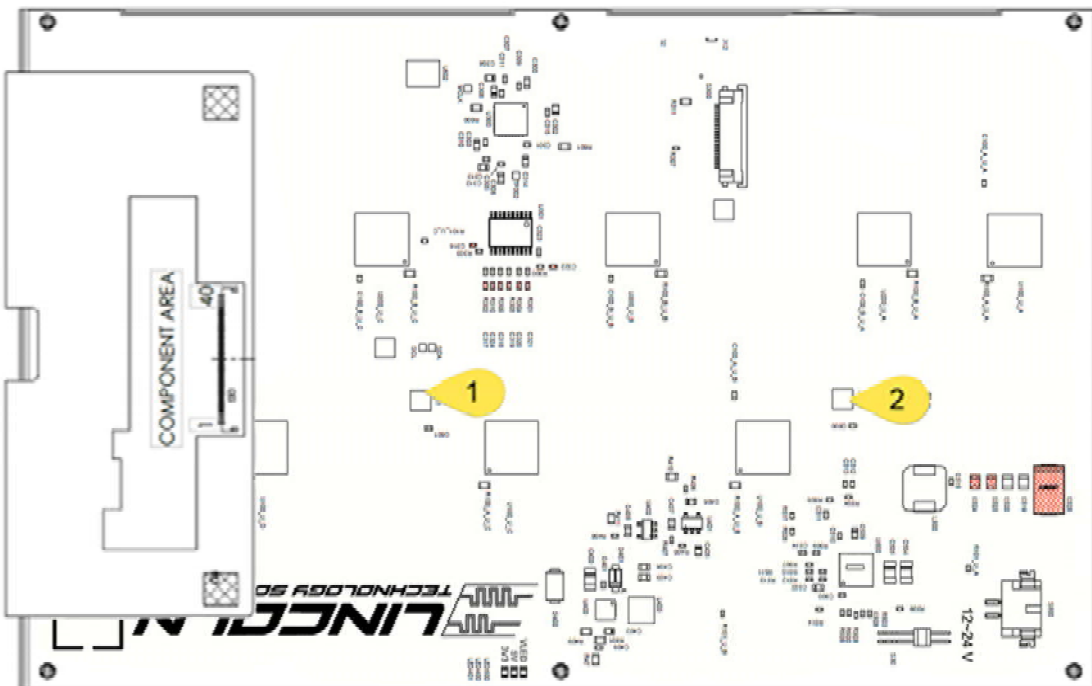

Positions 1 and 2 correspond to the temperature sensor locations.

Optical Characteristics

The following measurements were made using a Klein Instrument K-80 contact probe. The aperture size of the Klein coupled with small size of the 7" screen required changing the standard checkerboard pattern from 4*6 to 3*4.

HDR Characteristics

TBD

Colorimetry Characteristics

Measurements are recorded after panel has been powered on for a minimum of 20 minutes.

Item	Symbol	Conditions	Specification			Unit	Note
			Min	Typ	Max		
Contrast Ratio	CR	Normal Viewing Angle	1200	10,000,000	-	-	(1)(3)
Red	x	LED ON	-	.6758	-	-	
	y		-	.3224	-		
Green	x	LED ON	-	.1672	-	-	
	y		-	.7523	-		
Blue	x	LED ON	-	.1464	-	-	
	y		-	.0883	-		
White Point	x	LED ON	-	.2679	-	-	
	y		-	.315	-		
Luminance	L	Ta = 25 °C	tbd	1800	-	cd/m2	(1)
Color Gamut	CG		105	110	-	%	DCI-P3
Response Time	Tr Tf	Ta = 25°C	-	11	20	ms	(1)(4)

Note 1: Measurement setup

The LCD module should be stabilized at a given temperature for 2 hours to avoid abrupt temperature change during measurement. After temperature saturation measurement should be executed.

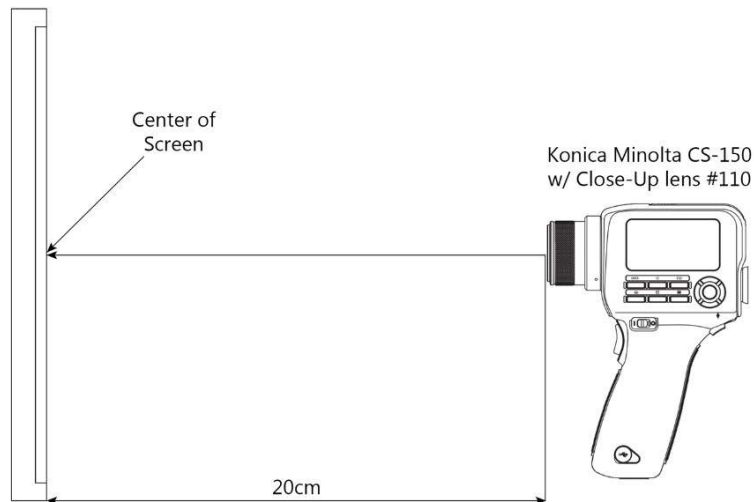
**Note 2: Brightness Uniformity**

Brightness uniformity = (Minimum Luminance of 5 points / Max Luminance of 5 points) * 100

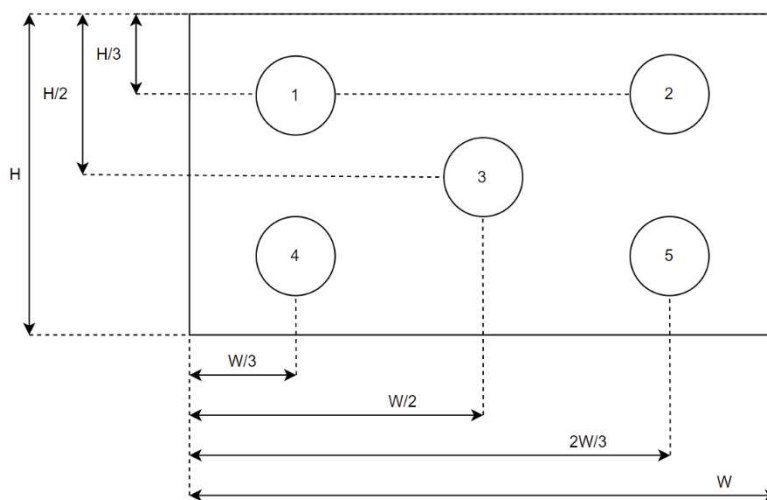

Note 3: Viewing Angle

Definition of viewing angle for Y+/- and X+/- is as follows.

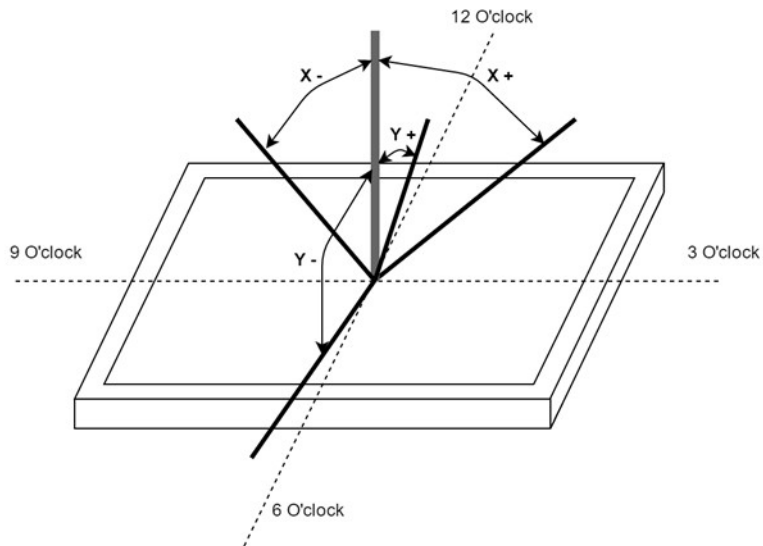
**Note 4: Response Time**

Definition of response time as follows below.

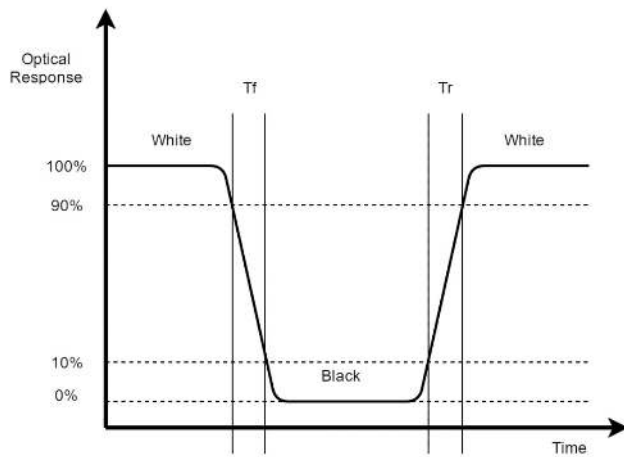

Packaging

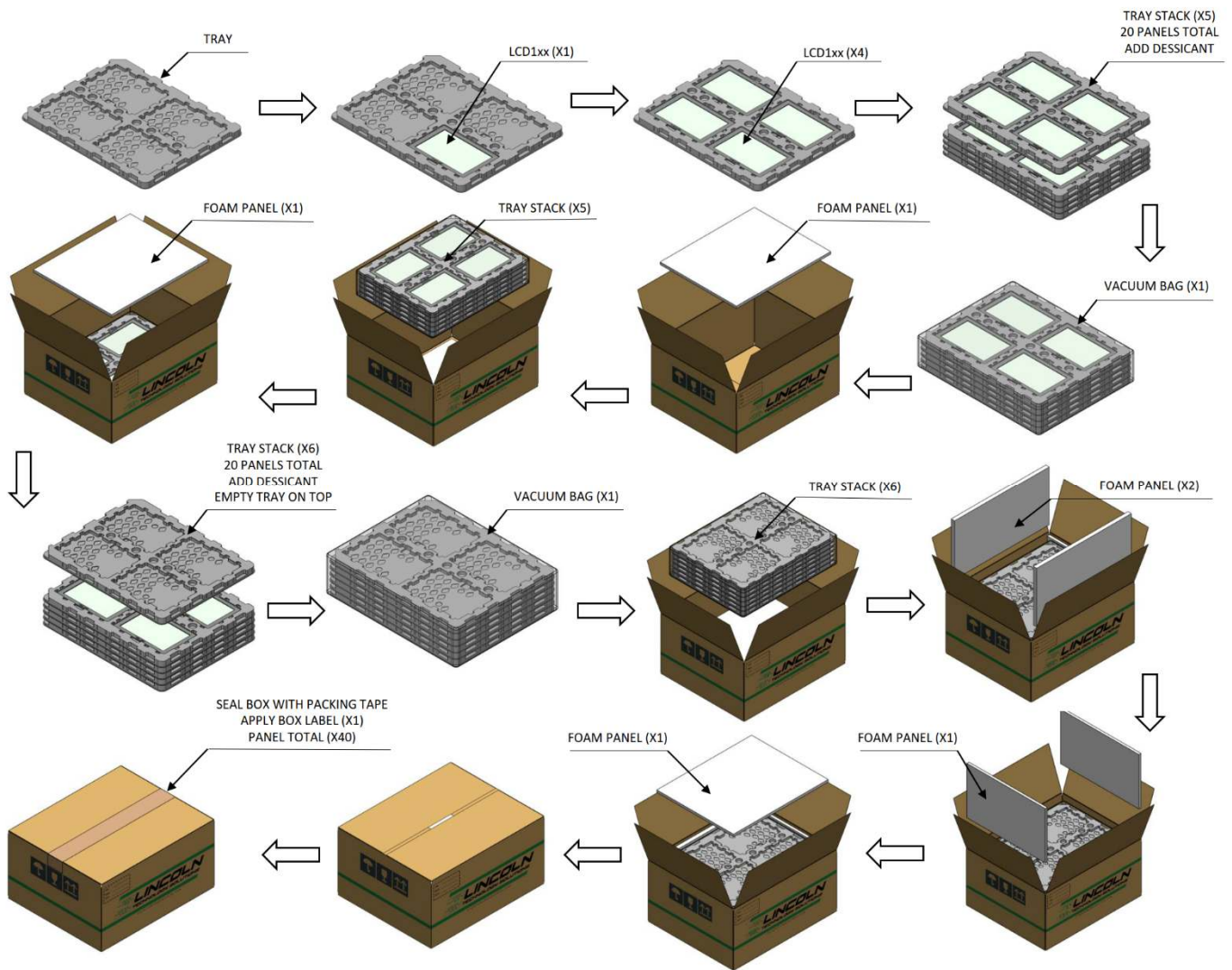

Quality & Inspection Criteria

Terminologies:

LCD: Liquid Crystal Display; Each pixel contains three dots of R, G, and B (sub-pixel).

Bright Dot: 1 sub-pixel is a dot. Defects should be larger than 1/2 of a sub-pixel. Dots that are not visible through a 5% ND Filter or smaller than 1/2 of sub-pixel size will not be counted as a dot defect.

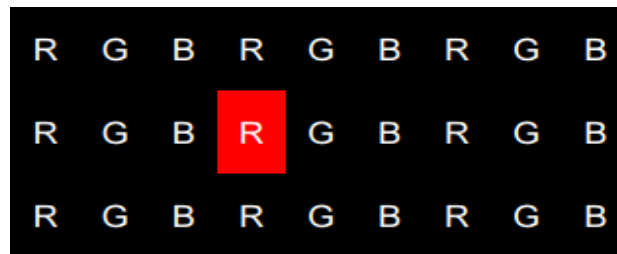
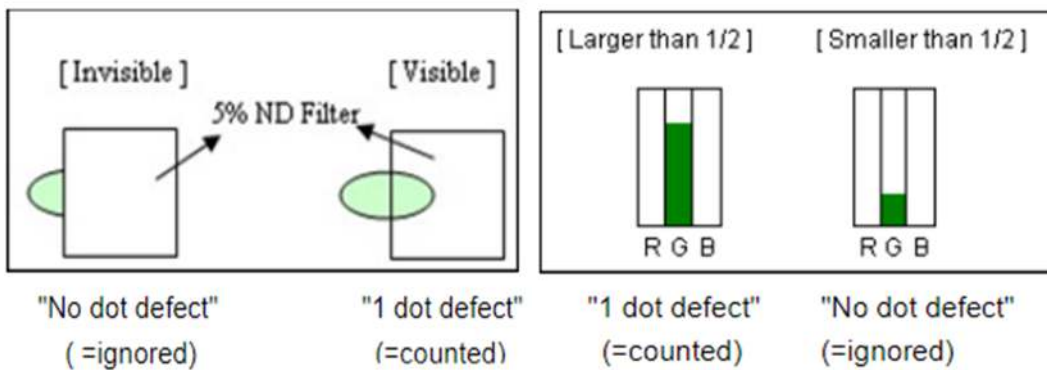

Dark Dot: Any single sub-pixel that does not light up in a white screen or another non-black screen is called a dark dot.

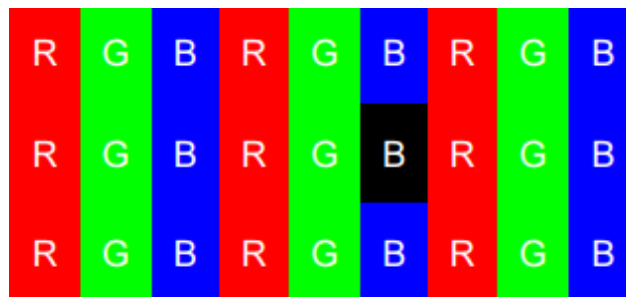

Two adjacent dots (horizontal direction): Use the bright dot illustration as an example to demonstrate two horizontal consecutive dots.

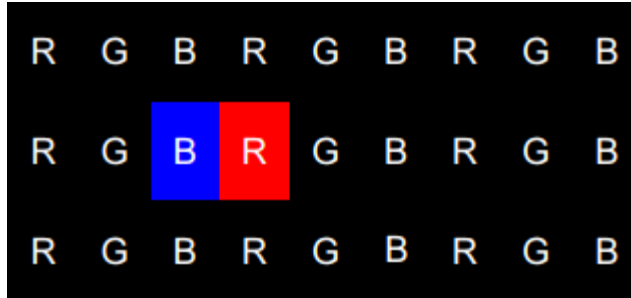

Two adjacent dots (vertical direction): Use the bright spot illustration as an example to demonstrate two vertical consecutive dots.

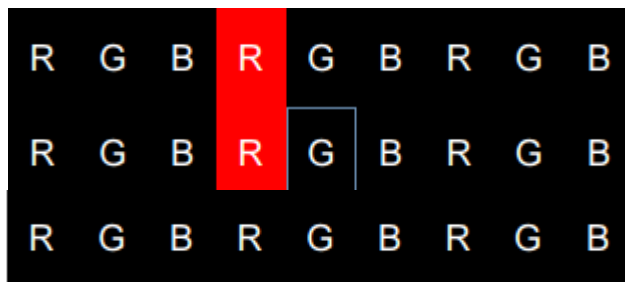

Two adjacent dots (bevel direction): Use the bright spot illustration as an example to demonstrate two consecutive dots in the bevel direction.

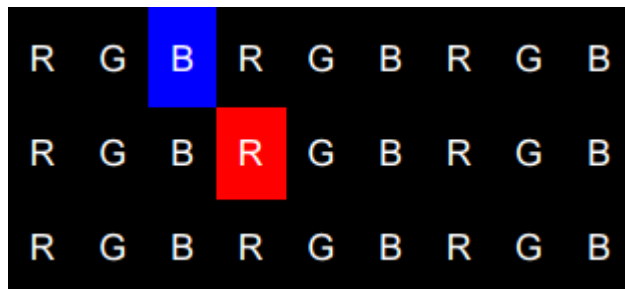

Three or more adjacent dots (horizontal): Use the bright spot illustration as an example to demonstrate three or more consecutive horizontal and vertical dots.

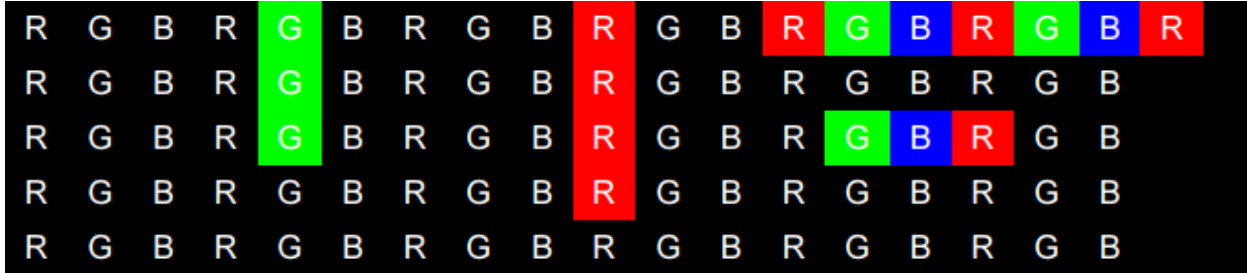
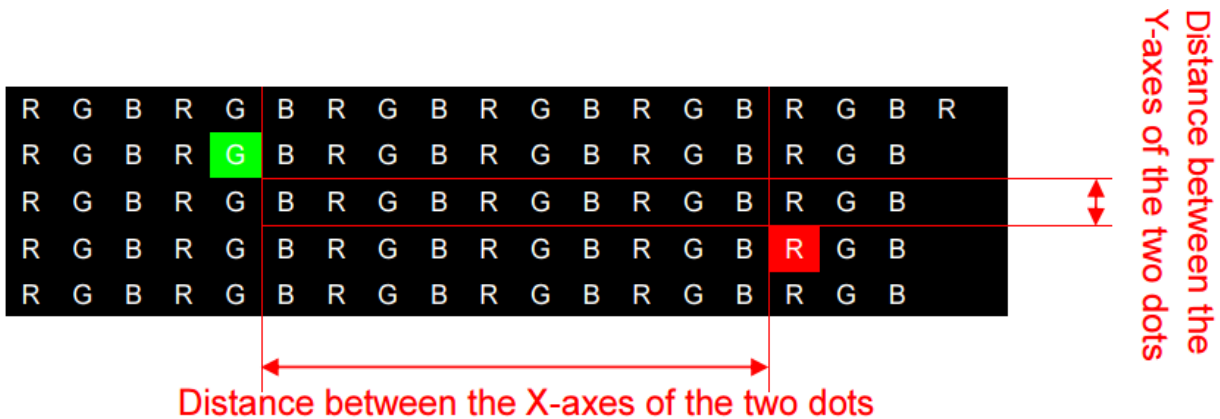

Illustration of spacing between two dots: (Distance is the relative distance between the X-axes of the two dots or the relative distance between the Y-axes of the two dots, whichever is larger)



Functional Test

The LCD display testing program should display the following screens in order: all red, all green, all blue, all white, all gray, all black.

Inspection Requirements

After booting the system (single illumination), there are no non-display, unlit backlight, dark backlight, blinking, or other abnormal signs, and there are no bright lines, dark lines, or bright rims/leakage of light close to the LCD bezel.

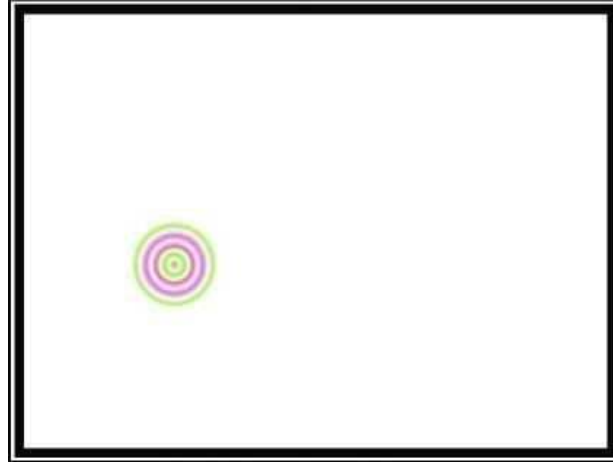
Newton's Ring

Under high temperature and high humidity conditions, uneven deformations caused by heat in different layers of the LCD module will result in the display of an all-white screen. However, this condition can be recovered when temperature is resumed under normal circumstances. A specific determination can be conducted according to the operating conditions and storage conditions defined in the product's technical specifications. Any exception will be negotiated and mutually agreed by both parties. (Ripples are not permitted at fixed locations. For ripples at non-fixed locations, they are OK if they disappear within two seconds.)

LCD blaze

Uneven internal LCD installation, surface deformation of the LCD polarizer, internal structural interference of the LCD module, damaged LCD backlight plates, and other factors may cause partial fading of color on the LCD display. When observed from a certain incident angle (upper 10°, lower 3°, 40° on both sides), they will appear as white cicatrices, typically about the size of a grain of rice. In serious cases, they accumulate in large patches or stripes, appear in different degrees under various colors (red, blue, green, black, gray, white), and are especially obvious under an all-gray screen. Blazes with diameters $\geq 0.5\text{mm}$ are not allowed: for those with diameters under 0.5 mm, 2 are acceptable if the space between them is $\geq 15\text{mm}$. Card chromatic aberration ratio versus ND Filter: $1.0 + 0.3$ standard = 5% ND Filer (see definition of Mura).

Mura

Mura refers to the unevenness and irregularity that is visible in the image. It is difficult for visual inspection to recognize the non-uniform brightness or mura. Mura detection is subjective and therefore doesn't have pass/fail criteria. There are several precautions to take which can avoid mura. Avoid high ambient temperatures around the module, frame warpage and high temperature operation over long periods of time. Utilize screen savers to avoid mura.

Inspection Conditions

Inspection distance should be 35cm ± 5cm with a FujiFilm ND-LCD 5% filter approximately 5cm from the backlight surface.

Viewing angle: 90° ± 5°.

Room temperature: 23+/- 2°C

Humidity: 60 +/- 10%

Inspection Ambient Illumination: 300-700 LUX

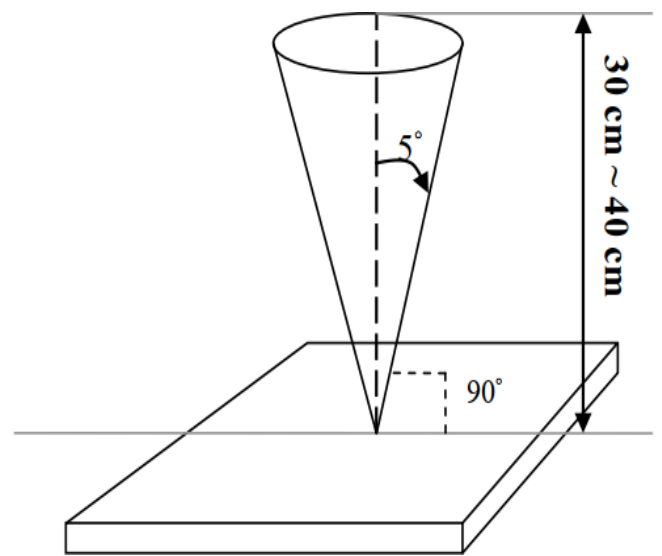
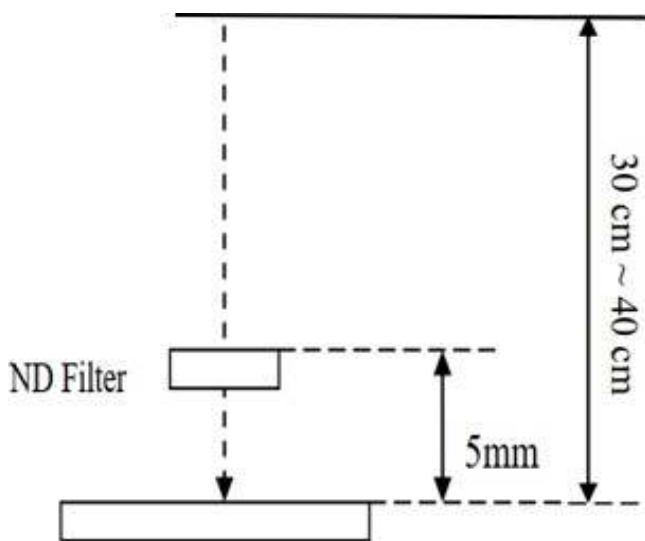

Acceptance Criteria Table:

There should be no corrosion or cracking, or an uneven coating layer on LCD display surface, and there should be no sign of coagulation, flaking, cracking, or wear. The definition of minor defects and acceptance criteria are shown in the following table:

Item	Size	Unit	Acceptance qty.
Unfelt scratch visible with backlight off.	W < 0.05	mm	Ignore
	W > .05 and < .10 L > .3 and < 3.0	mm	4
	W > .10 or L > 3.0	mm	none
	Visible with backlight on		none
Felt scratch	None allowed		
Dent visible with backlight off	D < .2	mm	Ignore
	D > .2 and < .5	mm	5
	Spacing between defects must be > 30mm		
	D > .5	mm	none
	Visible with backlight on		none
Bubble visible with backlight off	D < .2	mm	Ignore
	D > .2 and < .5	mm	5
	D > .5	mm	none
	Visible with backlight on		none
	W < .05		Ignore

Item	Size	Unit	Acceptance qty.
Foreign material (line shape) visible with backlight on		mm	
	W > .05 and < .10 L > .3 and < 2.0	mm	4
	W > .10 or L > 2.0	mm	none
Foreign material (dot shape) visible with backlight on	D < .2	mm	Ignore
	D > .2 and < .5	mm	5
	D > .5	mm	none
Bright dot defect(lit)	1 dot	-	4
	2 adjacent dots	-	0
Dark dot defect (not lit)	1 dot	-	5
	2 adjacent dots	-	2
	3 adjacent dots	-	0

Appendix 1 - Drawing