

10 9 8 7 6 5 4 3 2 1

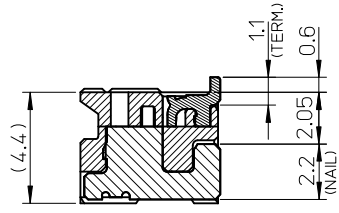

SECTION Z-Z

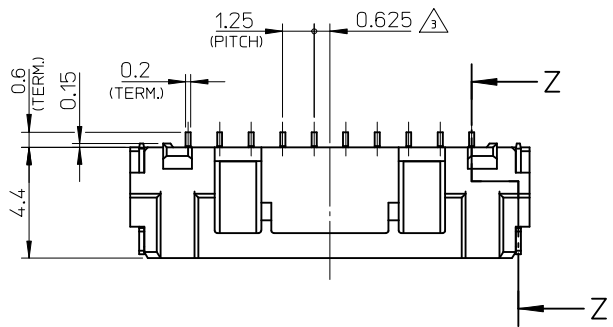
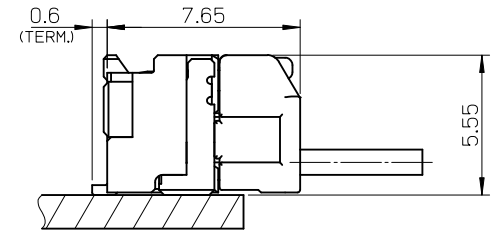
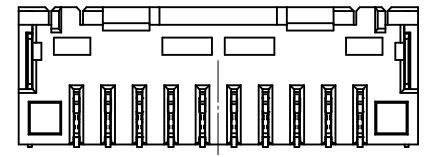
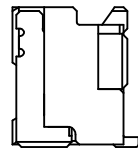
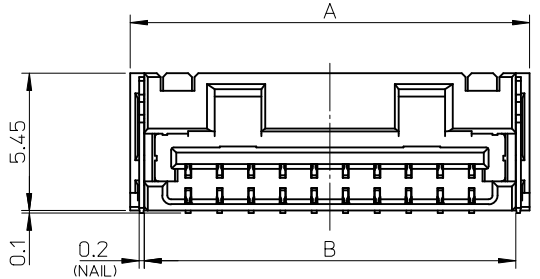
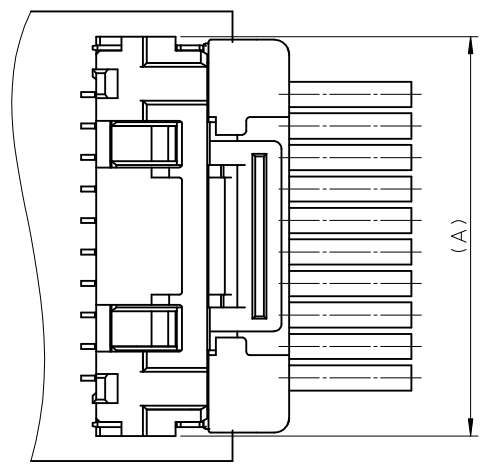

嵌合部
MATED CONNECTORS

NOTES

1. 嵌合相手: 502380-****
MATE WITH : 502380-****
2. 端子テール部 及び ネイルの平坦度: 0.1MAX.
TAIL AND NAIL COPLANARITY TO BE 0.1 MAX.
3. 極数/2=偶数に適用。
APPLY FOR CKT. SIZE / 2 = EVEN.
4. 端子テール部 及び ネイルに錫めっきを使用しているため、
外観に摺動痕が付く場合が御座います。
THE WOUND OF FRICTION MIGHT ADHERE TO EXTERNALS
BECAUSE THE TIN PLATING IS USED FOR THE TAIL AND NAIL.
5. 本製品のプラスチック部に黒点等が確認される場合や
色合いが異なる場合がありますが、製品性能に影響はありません。
THERE IS NO INFLUENCE IN THE PRODUCT PERFORMANCE THOUGH
THE BLACK SPOT ETC. MIGHT BE CONFIRMED TO THE PLASTIC PART
OF THIS PRODUCT AND THE SHADE MIGHT BE DIFFERENT.

2	10.7	11.5	17.5	21	22.1	502386-15**	15
2	9.45	10.25	16.25	19.75	20.85	502386-14**	14
2	8.2	9	15	18.5	19.6	502386-13**	13
2	6.95	7.75	13.75	17.25	18.35	502386-12**	12
2	5.7	6.5	12.5	16	17.1	502386-11**	11
2	4.45	5.25	11.25	14.75	15.85	502386-10**	10
2	3.2	4	10	13.5	14.6	502386-09**	9
2.6	1.95	2.75	8.75	12.25	13.35	502386-08**	8
F	E	D	C	B	A	EMBOSSED TAPE PACKAGE オーダー番号 ORDER No.	極数 CKT. NO.

番号 NO.	部品 PART	材質 MATERIAL
①	ハウジング HOUSING	耐熱性樹脂 UL94V-0 色:SHEET 3 参照 HEATPROOF RESIN UL94V-0 COLOR : SEE SHEET 3
②	ターミナル TERMINAL	銅合金 COPPER ALLOY 錫めっき : 1.0 micro-meter MIN. TIN (TAIL AREA) ニッケルめっき(下地): 1.0 micro-meter MIN. NICKEL (UNDER PLATING)
③	ネイル NAIL	銅合金 COPPER ALLOY 錫めっき: 1.0 micro-meter MIN. TIN ニッケルめっき(下地): 1.0 micro-meter MIN. NICKEL (UNDER PLATING)

REVISED EC NO.: J2013-0870 DRWN: KWASHIO 2013/02/07 CHKD: KASAKAWA 2013/02/13 APPR: Y01TO 2013/02/13	DESCRIPTION REV	GENERAL TOLERANCES (UNLESS SPECIFIED)		DIMENSION STYLE MM ONLY		SCALE 5:1	DESIGN UNITS METRIC	THIRD ANGLE PROJECTION	
		10 UNDER	±0.2	DRAWN BY T. MIYAZAKI	DATE 2006/08/28	TITLE 1.25 W/B CONN. SINGLE R/A REC. ASS'Y 8-15CKT. -LEAD FREE-			
		10 OVER 30 UNDER	±0.25	CHECKED BY K. ASAKAWA	DATE 2006/08/28				
		30 OVER	±0.3	APPROVED BY Y0. ITO	DATE 2006/08/28				
ANGULAR ±3 °		DRAFT WHERE APPLICABLE MUST REMAIN WITHIN DIMENSIONS		MATERIAL NO. SEE TABLE		DOCUMENT NO. SD-502386-002		SHEET NO. 1 OF 3	
SIZE A3 THIS DRAWING CONTAINS INFORMATION THAT IS PROPRIETARY TO MOLEX INCORPORATED AND SHOULD NOT BE USED WITHOUT WRITTEN PERMISSION									

9 8 7 6 5 4 3 2

10 9 8 7 6 5 4 3 2 1

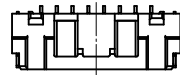

8 CKT.

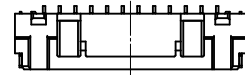

12 CKT.

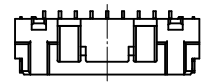

9 CKT.

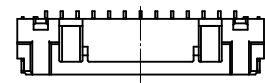

13 CKT.

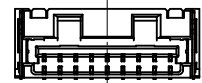

10 CKT.

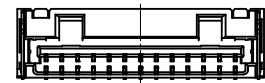

14 CKT.

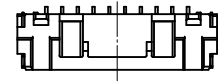

11 CKT.

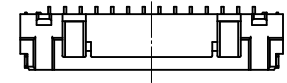

15 CKT.

極数の種類

KIND OF CKT. NO. (FRONT VIEW)

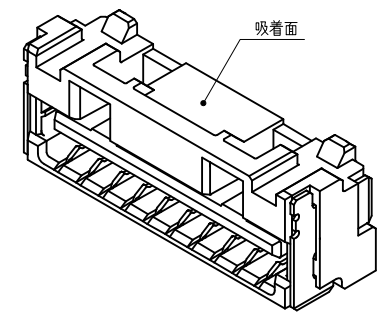
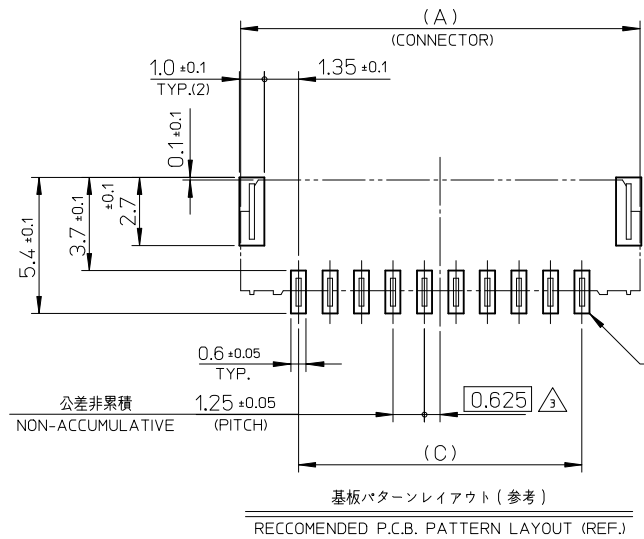
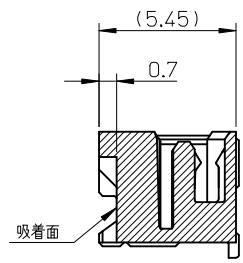
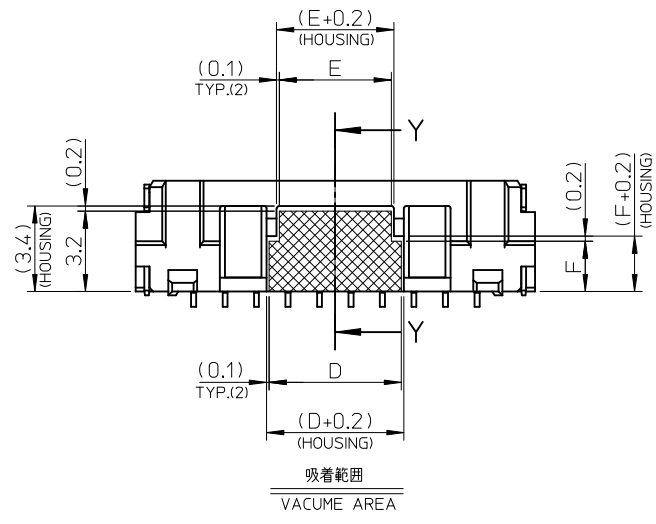

REVISED	EC NO.: J2013-0870	2013/02/07	GENERAL TOLERANCES (UNLESS SPECIFIED)	DIMENSION STYLE	SCALE	DESIGN UNITS	THIRD ANGLE PROJECTION
	DRWN:KASHIO	2013/02/13	10 UNDER ±0.2	MM ONLY	5:1	METRIC	
	CHKD:KASAKAWA	2013/02/13	10 OVER 30 UNDER ±0.25	DRAWN BY	DATE	TITLE	
	APPR:Y0 ITO	2013/02/13	30 OVER ±0.3	T. MIYAZAKI	2006/08/28	1.25 W/B CONN. SINGLE R/A REC. ASS'Y 8-15CKT. -LEAD FREE-	
DESCRIPTION	ANGULAR ±3 °	DRAFT WHERE APPLICABLE MUST REMAIN WITHIN DIMENSIONS	CHECKED BY	DATE	APPROVED BY	DATE	
REV			Y0. ITO	2006/08/28			
			MATERIAL NO.	SEE TABLE	DOCUMENT NO.	SD-502386-002	SHEET NO.
			SIZE	A3	THIS DRAWING CONTAINS INFORMATION THAT IS PROPRIETARY TO MOLEX INCORPORATED AND SHOULD NOT BE USED WITHOUT WRITTEN PERMISSION		

9 8 7 6 5 4 3 2

HSG COLOR : ORANGE		
--	502386-**28	15
--		14
--		13
--		12
--		11
--		10
502386-0948		9
--		8
EMBOSSED TAPE PACKAGE オーダー番号ORDER No.	コネクタ シリズ CONNECTOR SERIES	極数 Ckt. No.

HSG COLOR : GREEN		HSG COLOR : BLUE		HSG COLOR : YELLOW		HSG COLOR : RED		HSG COLOR : BLACK		HSG COLOR : NATURAL		
502386-1546	502386-**26	502386-1544	502386-**24	--	502386-**23	502386-1542	502386-**22	502386-1541	502386-**21	502386-1570	502386-**09	
502386-1446		502386-1444		--		502386-1442		502386-1441		502386-1470		
502386-1346		502386-1344		--		502386-1342		502386-1341		502386-1370		
502386-1246		502386-1244		--		502386-1242		502386-1241		502386-1270		
502386-1146		502386-1144		--		502386-1142		502386-1141		502386-1170		
502386-1046		502386-1044		--		502386-1042		502386-1041		502386-1070		
502386-0946		502386-0944		502386-0943		502386-0942		502386-0941		502386-0970		
502386-0846		502386-0844		--		502386-0842		502386-0841		502386-0870		
EMBOSSED TAPE PACKAGE オーダー番号ORDER No.	コネクタ シリズ CONNECTOR SERIES	EMBOSSED TAPE PACKAGE オーダー番号ORDER No.	コネクタ シリズ CONNECTOR SERIES	EMBOSSED TAPE PACKAGE オーダー番号ORDER No.	コネクタ シリズ CONNECTOR SERIES	EMBOSSED TAPE PACKAGE オーダー番号ORDER No.	コネクタ シリズ CONNECTOR SERIES	EMBOSSED TAPE PACKAGE オーダー番号ORDER No.	コネクタ シリズ CONNECTOR SERIES	EMBOSSED TAPE PACKAGE オーダー番号ORDER No.	コネクタ シリズ CONNECTOR SERIES	極数 Ckt. No.

REVISED EC NO. J2013-0870 DRWN:KASHIO 2013/02/07 CHKD:KASAKAWA 2013/02/13 APPR:Y.ITO 2013/02/13	DESCRIPTION	GENERAL TOLERANCES (UNLESS SPECIFIED)	DIMENSION STYLE MM ONLY	SCALE ----	DESIGN UNITS METRIC	THIRD ANGLE PROJECTION
	REV	10 UNDER ±0.2	DRAWN BY DATE T.MIYAZAKI 2006/08/28	TITLE 1.25 W/B CONN. SINGLE R/A REC. ASS'Y 8-15CKT. -LEAD FREE-		
		10 OVER 30 UNDER ±0.25	CHECKED BY DATE K.ASAKAWA 2006/08/28			
		30 OVER ±0.3	APPROVED BY DATE Y.O.ITO 2006/08/28			
		ANGULAR ±3 °	MATERIAL NO. SEE TABLE	DOCUMENT NO. SD-502386-002	SHEET NO. 3 OF 3	
	DRAFT WHERE APPLICABLE MUST REMAIN WITHIN DIMENSIONS	SIZE A3	THIS DRAWING CONTAINS INFORMATION THAT IS PROPRIETARY TO MOLEX INCORPORATED AND SHOULD NOT BE USED WITHOUT WRITTEN PERMISSION			

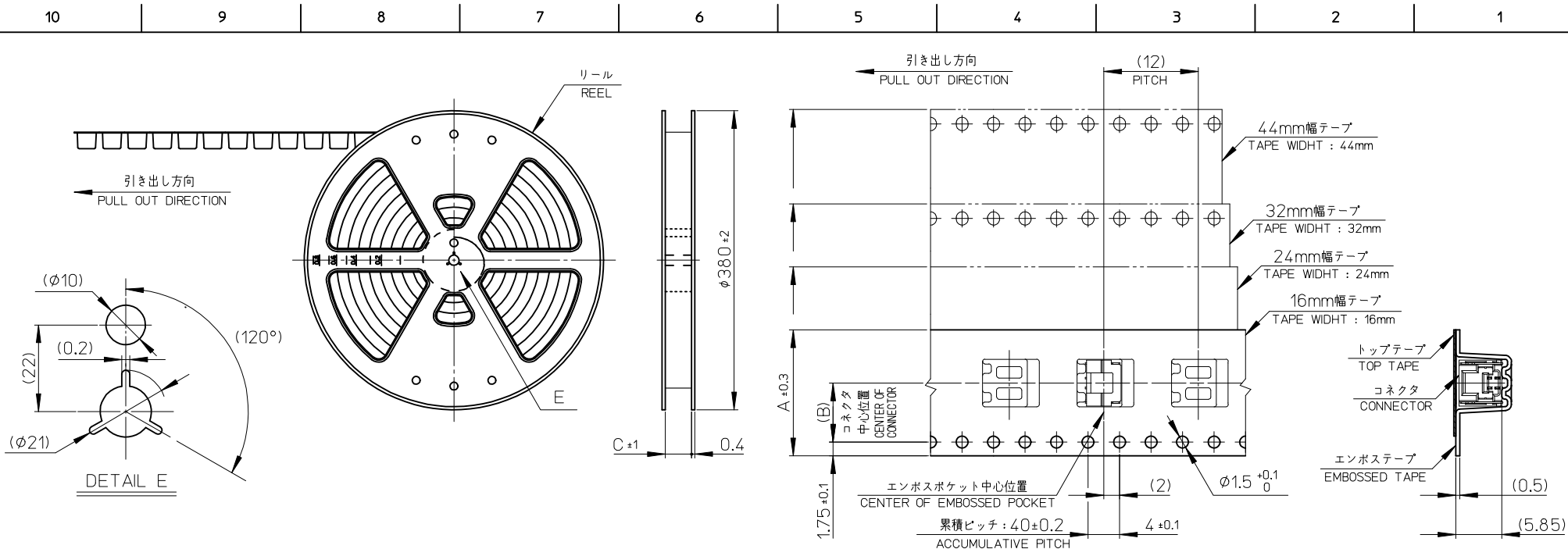

NOTES

- 製品詳細寸法については、SD-502386-001, -002 を参照下さい。
PLEASE REFER TO SD-502386-001, -002 FOR THE DETAILED DIMENSION OF THE CONNECTOR.
- 梱包数量 : 1200個
NUMBER OF CONNECTORS : 1200 PIECES/REEL.
- リードテープ長さ
LEAD TAPE LENGTH

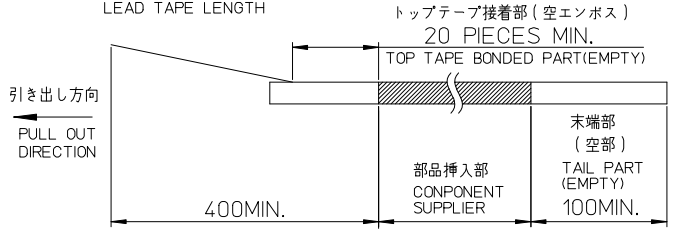

- 材料
MATERIAL
キャリアテープ : ポリスチレン
CARRIER TAPE : POLYSTYRENE
トップテープ : ポリエステル, ポリエチレン, ポリエチレンテレフタレート
TOP TAPE : POLYESTER, POLYETHYLENE, POLYETHYLENE TEREPHTHALATE
リール : ポリスチレン <リサイクル材を含む>
REEL : POLYSTYRENE <RECYCLE MATERIAL CONTAINED>
- ELV 及び RoHS 適合品
ELV AND RoHS COMPLIANT

45.5	20.2	44	502386-15**	15
45.5	20.2	44	502386-14**	14
33.5	14.2	32	502386-13**	13
33.5	14.2	32	502386-12**	12
33.5	14.2	32	502386-11**	11
33.5	14.2	32	502386-10**	10
25.5	11.5	24	502386-09**	9
25.5	11.5	24	502386-08**	8
25.5	11.5	24	502386-07**	7
25.5	11.5	24	502386-06**	6
25.5	11.5	24	502386-05**	5
25.5	11.5	24	502386-04**	4
17.5	7.5	16	502386-03**	3
17.5	7.5	16	502386-02**	2

REVISED EC NO.: J2013-0870 DRAWN: KWASHIO 2013/02/07 CHKD: KASAKAWA 2013/02/13 APPR: YO ITO 2013/02/13	DESCRIPTION	GENERAL TOLERANCES (UNLESS SPECIFIED)		DIMENSION STYLE MM ONLY		SCALE ---	DESIGN UNITS METRIC		THIRD ANGLE PROJECTION	
		10 UNDER	±0.2	DRAWN BY	DATE	TITLE				
		10 OVER 30 UNDER	±0.25	T. MIYAZAKI	2006/10/16	1.25 W/B CONN. SINGLE R/A REC. EMBTP PKG				
		30 OVER	±0.3	K. ASAKAWA	2006/10/16					
ANGULAR	±3 °	APPROVED BY	DATE	MATERIAL NO.		DOCUMENT NO.		SHEET NO.		
DRAFT WHERE APPLICABLE MUST REMAIN WITHIN DIMENSIONS		SEE TABLE		YO. ITO 2006/10/16		SD-502386-003		1 OF 2		
		SIZE A3		THIS DRAWING CONTAINS INFORMATION THAT IS PROPRIETARY TO MOLEX INCORPORATED AND SHOULD NOT BE USED WITHOUT WRITTEN PERMISSION						

WITHOUT CAPTON TAPE			WITH CAPTON TAPE										
HSG COLOR : ORANGE			HSG COLOR : GREEN		HSG COLOR : BLUE		HSG COLOR : RED		HSG COLOR : BLACK		HSG COLOR : NATURAL		
502386-**28	—//—	15	—//—	—//—	—//—	—//—	—//—	—//—	—//—	—//—	—//—	—//—	15
	—//—	14	—//—	—//—	—//—	—//—	—//—	—//—	—//—	—//—	—//—	—//—	14
	—//—	13	—//—	—//—	—//—	—//—	—//—	—//—	—//—	—//—	—//—	—//—	13
	—//—	12	—//—	—//—	—//—	—//—	—//—	—//—	—//—	—//—	—//—	—//—	12
	—//—	11	—//—	—//—	—//—	—//—	—//—	—//—	—//—	—//—	—//—	—//—	11
	—//—	10	—//—	—//—	—//—	—//—	—//—	—//—	—//—	—//—	—//—	—//—	10
	502386-0948	9	—//—	—//—	—//—	—//—	—//—	—//—	—//—	—//—	—//—	—//—	9
	—//—	8	—//—	—//—	—//—	—//—	—//—	—//—	—//—	—//—	—//—	—//—	8
	—//—	7	—//—	—//—	—//—	—//—	—//—	—//—	—//—	—//—	—//—	—//—	7
	—//—	6	—//—	—//—	—//—	—//—	—//—	—//—	—//—	—//—	—//—	—//—	6
—//—	5	502386-0736	502386-0636	502386-0734	502386-0634	502386-0732	502386-0632	502386-0731	502386-0631	502386-0730	502386-0630	7	
—//—	4	502386-0536	502386-0436	502386-0534	502386-0434	502386-0532	502386-0432	502386-0531	502386-0431	502386-0530	502386-0430	6	
—//—	3	502386-0436	502386-0336	502386-0434	502386-0334	502386-0432	502386-0332	502386-0431	502386-0331	502386-0430	502386-0330	5	
—//—	2	502386-0336	502386-0236	502386-0334	502386-0234	502386-0332	502386-0232	502386-0331	502386-0231	502386-0330	502386-0230	4	
コネクタ シリーズ	製品番号	極数	コネクタ シリーズ	製品番号	コネクタ シリーズ	製品番号	コネクタ シリーズ	製品番号	コネクタ シリーズ	製品番号	コネクタ シリーズ	製品番号	極数
CONNECTOR SERIES	MATERIAL NO.	(KT, NO.)	CONNECTOR SERIES	MATERIAL NO.	CONNECTOR SERIES	MATERIAL NO.	CONNECTOR SERIES	MATERIAL NO.	CONNECTOR SERIES	MATERIAL NO.	CONNECTOR SERIES	MATERIAL NO.	(KT, NO.)

WITHOUT CAPTON TAPE												
HSG COLOR : GREEN			HSG COLOR : BLUE		HSG COLOR : YELLOW		HSG COLOR : RED		HSG COLOR : BLACK		HSG COLOR : NATURAL	
502386-**26	502386-1546	502386-1544	—//—	502386-1542	502386-1541	502386-1570	15					
	502386-1446	502386-1444	—//—	502386-1442	502386-1441	502386-1470	14					
	502386-1346	502386-1344	—//—	502386-1342	502386-1341	502386-1370	13					
	502386-1246	502386-1244	—//—	502386-1242	502386-1241	502386-1270	12					
	502386-1146	502386-1144	—//—	502386-1142	502386-1141	502386-1170	11					
	502386-1046	502386-1044	—//—	502386-1042	502386-1041	502386-1070	10					
	502386-0946	502386-0944	502386-0943	502386-0942	502386-0941	502386-0970	9					
	502386-0846	502386-0844	—//—	502386-0842	502386-0841	502386-0870	8					
	502386-0746	502386-0744	—//—	502386-0742	502386-0741	502386-0770	7					
	502386-0646	502386-0644	—//—	502386-0642	502386-0641	502386-0670	6					
	502386-0546	502386-0544	—//—	502386-0542	502386-0541	502386-0570	5					
	502386-0446	502386-0444	—//—	502386-0442	502386-0441	502386-0470	4					
	502386-0346	502386-0344	—//—	502386-0342	502386-0341	502386-0370	3					
	502386-0246	502386-0244	—//—	502386-0242	502386-0241	502386-0270	2					
	コネクタ シリーズ	製品番号	コネクタ シリーズ	製品番号	コネクタ シリーズ	製品番号	コネクタ シリーズ	製品番号	コネクタ シリーズ	製品番号	極数	
CONNECTOR SERIES	MATERIAL NO.	CONNECTOR SERIES	MATERIAL NO.	CONNECTOR SERIES	MATERIAL NO.	CONNECTOR SERIES	MATERIAL NO.	CONNECTOR SERIES	MATERIAL NO.	(KT, NO.)		

REVISED EC NO.: J2013-0870 2013/02/07 DRWN: KWASHIO 2013/02/13 CHKD: KASAKAWA 2013/02/13 APPR: Y01TO 2013/02/13	GENERAL TOLERANCES (UNLESS SPECIFIED)		DIMENSION STYLE MM ONLY		SCALE ---	DESIGN UNITS METRIC	THIRD ANGLE PROJECTION
	10 UNDER	±0.2	DRAWN BY	DATE	TITLE		
	10 OVER 30 UNDER	±0.25	T. MIYAZAKI	2006/10/16	1.25 W/B CONN. SINGLE R/A REC. EMBTP PKG		
	30 OVER	±0.3	K. ASAKAWA	2006/10/16	molex		
	ANGULAR ±3 °		APPROVED BY	DATE	MATERIAL NO.	DOCUMENT NO.	SHEET NO.
DRAFT WHERE APPLICABLE MUST REMAIN WITHIN DIMENSIONS		SEE TABLE		SD-502386-003		2 OF 2	
		THIS DRAWING CONTAINS INFORMATION THAT IS PROPRIETARY TO MOLEX INCORPORATED AND SHOULD NOT BE USED WITHOUT WRITTEN PERMISSION					